



## Exposed part for concealed 2-outlet mixer CHRONOS\_CR002300

MODEL **CR002300**

Exposed part for concealed 2-outlet mixer, 2-Way rotating diverter, without concealed part, for item Easy-Box ZB000230

### AVAILABLE FINISHINGS

-  **21** 21 Chrome
-  **2F** 2F Brushed Nickel
-  **2Q** 40 Matt Black

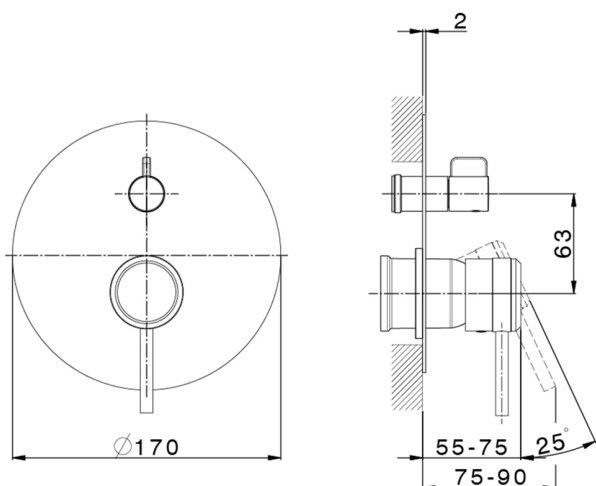
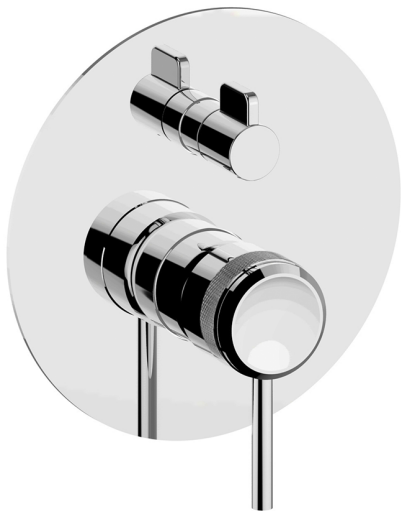

### CHARACTERISTICS

Installation **Concealed**  
 Required concealed parts **ZB000230**



## Concealed single lever bath-shower mixer Easy-Box CONCEALED\_ZB000230

MODEL **ZB000230**

Concealed single lever bath-shower mixer Easy-Box, 2-Way rotating diverter, without trim kit, with protection guard box

AVAILABLE FINISHINGS



**04** 04 Without finishing

CHARACTERISTICS

Concealed **1**  
 Cartridge Spare Parts **ZZ92909000**  
**35 mm Cartridge**

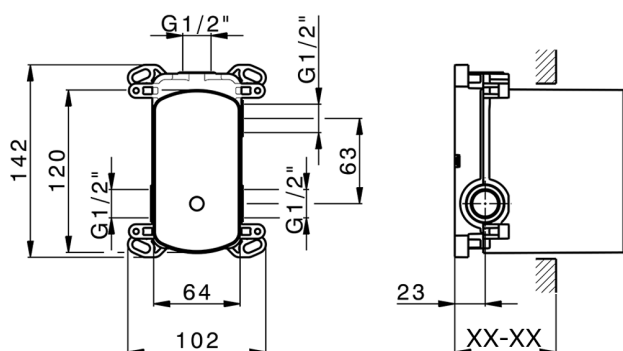

Piastra/Plate/Plaque/Platte/Placa

2-3mm: XX 65-85

10mm: XX 60-80



2024-09-20