





Single lever washbasin mixer DADO_DD000510



MODEL **DD000510**

Single lever washbasin mixer, with 1"1/4 automatic pop-up waste, G.3/8" stainless steel flexible hoses

AVAILABLE FINISHINGS

-  **21** 21 Chrome
-  **2B** 2B Polished Nickel
-  **2F** 2F Brushed Nickel
-  **40** 40 Matt Black
-  **4Q** 4Q Matt White

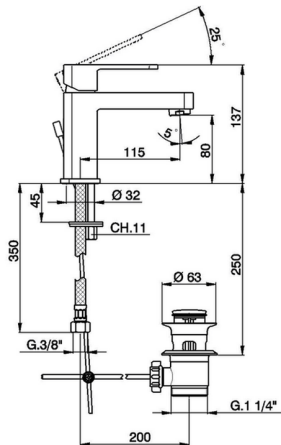

CHARACTERISTICS

Cartridge Spare Parts **ZZ94240000**

25 mm Cartridge



Single lever washbasin mixer DADO_DD000510

DD 00051 0

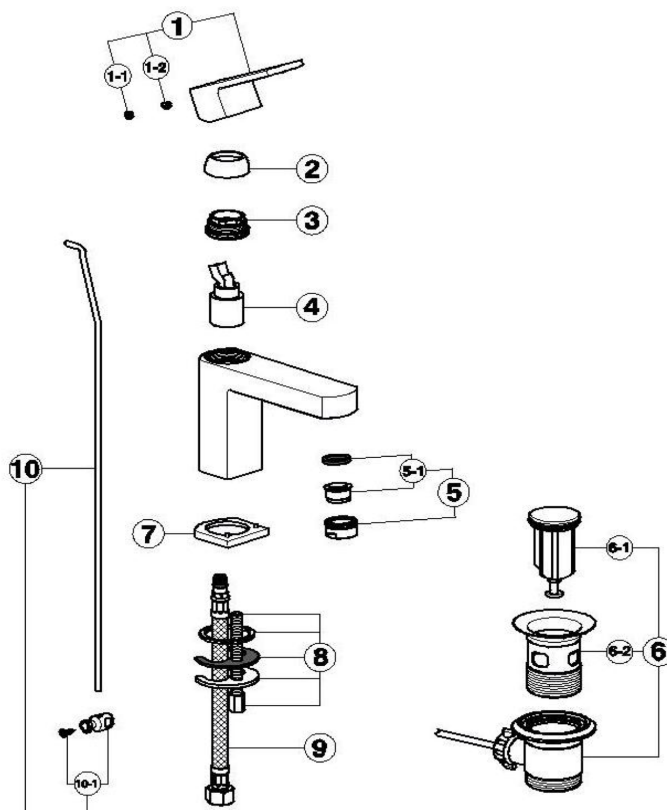
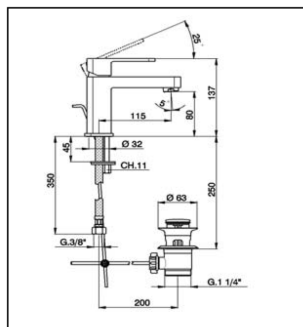

| NR | DESCRIZIONE DESCRIPTION DESCRIPCION BESCHREIBUNG DESCRIPCION | N.CODICE NR.CODE CODE NO. WERSKNR. N.CÓDIGO |
|-----|--|---|
| 1 | Leva monocomando "DD" Lever "DD" Hebel "DD" Palanca monomando "DD" Placchetta maniglia LS Plaque cache - vis crois LS | ZZ955930 |
| 1-1 | Cap for handle LS Abdeckkappe LS Griff Plaquita maneta LS | ZZ933710 |
| 1-2 | Grano punta coppa inox M.5x6 Vis speciale inox M.5x6 Madenschraube M.5x6 Clavija con punta copa acero inox M.5x6 | ZZ940630 |
| 2 | Copricartuccia monocomando Couvre-cartouche | ZZ955210 |
| 3 | Nut for mixing valve Mutter fuer Kartusche Casquete de fijación cartucho | ZZ955220 |
| 4 | Cartuccia monocomando Cartouche mitigeurs Mixing valve Kartusche Cartucho monomando | ZZ942400 |

| NR | DESCRIZIONE DESCRIPTION DESCRIPCION BESCHREIBUNG DESCRIPCION | N.CODICE NR.CODE CODE NO. WERSKNR. N.CÓDIGO |
|-----|---|---|
| 5 | Aeratore M24x1 IA Cascade Mousseur M24x1 IA Cascade Mousseur M24x1 IA Cascade Perlator M24x1 IA Cascade Aireador M24x1 IA Cascade | ZZ944150 |
| 5-1 | Cartuccia per aeratore M.24x1 Cascade Cartouche pour mousseur M.24x1 Cascade Mousseur cartridge M.24x1 Cascade Kartusche fuer Perlator M.24x1 Cascade Cartucho para aireador M.24x1 Cascade | ZZ933990 |
| 6 | Scarico automatico 1"1/4 sabbato Vidage automatique 1"1/4 sabbato Pop up waste 1"1/4 sabbato Ablaufgarnitur 1"1/4 sabbato Desagüe automático 1"1/4 arenado | ZZ927540 |
| 6-1 | Tappo completo scarico automatico 1"1/4 Bonde-vidage 1"1/4 Plug for pop up waste 1"1/4 Stopfen fuer Ablaufgarnitur kpl 1"1/4 Tapón completo columna desagüe automático 1"1 | ZZ929250 |
| 6-2 | Piletta per scarico automatico 1"1/4 Crépine pour vidage 1"1/4 Waste for bath drain 1"1/4 Ablauf fuer Ablaufgarnitur 1"1/4 Válvula para desagüe automático 1"1/4 | ZZ929240 |
| 7 | Basetta monocomando "DD" Bague "DD" Assembling ring "DD" Basis "DD" Base monomando lavabo "DD" | ZZ955230 |

| NR | DESCRIZIONE DESCRIPTION DESCRIPCION BESCHREIBUNG DESCRIPCION | N.CODICE NR.CODE CODE NO. WERSKNR. N.CÓDIGO |
|------|---|---|
| 8 | Set installazione monocomando monoforo Set installation Installation set single hole Befestigungsset Juego de instalación monomando | ZZ940690 |
| 9 | Flex M10x1-G3/8" L.420 Flex M10x1-G3/8" L.420 Flex M10x1-G3/8" L.420 Anschluss Schlauch M10x1-G3/8" L.420 Flexo M10x1-G3/8" L.420 | ZZ954110 |
| 10 | Astina scarico completa Ø 4 Tige Ø4 Rod Ø4 | ZZ933400 |
| 10-1 | Morsetto astina scarico automatico Jonction pour tige vidage Connection for pop-up rod Gelenstueck fuer Zugstange Abrazadera varilla desagüe automático | ZZ933430 |

DD000510

<https://en.huberitalia.com/single-lever-washbasin-mixer-dado-dd000510>

2024-12-22