

Exposed part for 3-outlet thermostatic mixer NUOVA KIRUNA_K2018200

MODEL **K2018200**

Exposed part for 3-outlet thermostatic mixer, with 3 outlet diverter, without concealed part, for item ZB018201

AVAILABLE FINISHINGS

-  **21** 21 Chrome
-  **26** 26 Old Copper
-  **2F** 2F Brushed Nickel
-  **2W** 2W Brushed Gold
-  **40** 40 Matt Black
-  **4Q** 4Q Matt White

CHARACTERISTICS

Installation **Concealed**
 Required concealed parts **ZB018201**

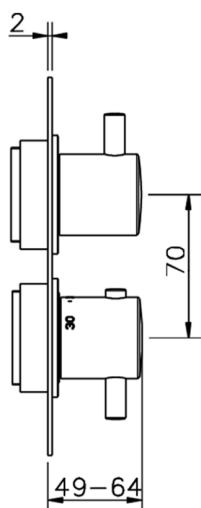

Thermostatic

The Huber thermostatic is your personal water manager, helping you to handle, control and save water and energy.



3-outlet Concealed thermostatic shower valve CONCEALED_ZB018201

MODEL **ZB018201**

3-Outlet Concealed thermostatic mixer, with 3-outlet diverter, without trim kit

AVAILABLE FINISHINGS



CHARACTERISTICS

Installation **Concealed**

Cartridge Spare Parts **24.04A.PP**

8x20 Plus P Thermostatic Valve

Concealed **1**

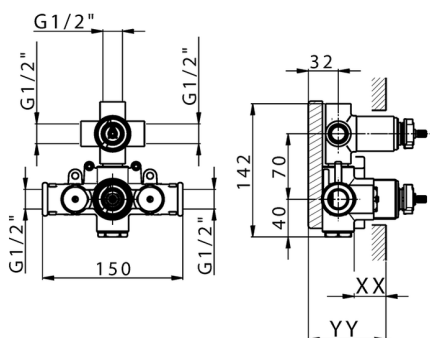

Piastra/Plate/Plaque/Platte/Placa

2-3mm: XX 25-40 YY 76-91

10 mm: XX 16-31 YY 65-80



DeviaStop

The Huber Devia Stop technology allows to adjust the water flow and to direct it to the selected output point (overhead soaker, hand shower, etc).



Thermostatic

The Huber thermostatic is your personal water manager, helping you to handle, control and save water and energy.



2024-11-15