

Exposed part for concealed 2-outlet mixer H2_H2002300



MODEL **H2002300**

Exposed part for concealed 2-outlet mixer, 2-Way rotating diverter, without concealed part, for item Easy-Box ZB000230

AVAILABLE FINISHINGS



CHARACTERISTICS

Installation **Concealed**

Required concealed parts **ZB000230**

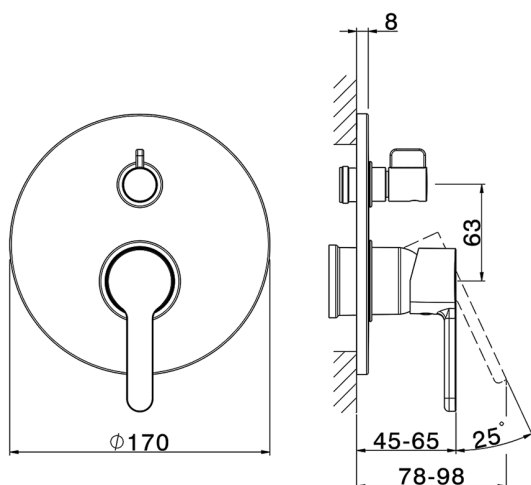

Concealed single lever bath-shower mixer Easy-Box CONCEALED_ZB000230

MODEL **ZB000230**

Concealed single lever bath-shower mixer Easy-Box, 2-Way rotating diverter, without trim kit, with protection guard box

AVAILABLE FINISHINGS



04 04 Without finishing

CHARACTERISTICS

Concealed **1**
 Cartridge Spare Parts **ZZ92909000**
35 mm Cartridge

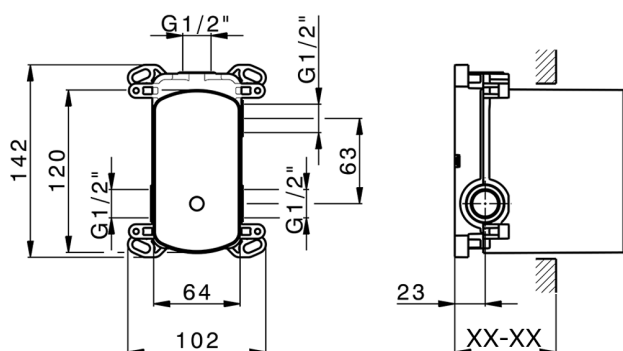

Piastra/Plate/Plaque/Platte/Placa

2-3mm: XX 65-85

10mm: XX 60-80



2024-11-24