

## Single lever washbasin mixer SOFT\_SF001510



MODEL **SF001510**

Single lever washbasin mixer, with 1"1/4 automatic pop-up waste, G.3/8" stainless steel flexible hose

AVAILABLE FINISHINGS



CHARACTERISTICS

Cartridge Spare Parts **ZZ95409000**

**35 mm Cartridge**

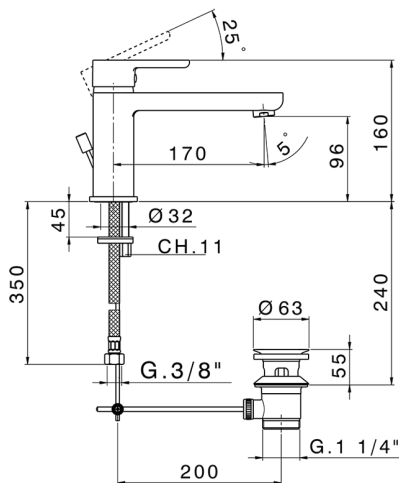

2026-06-15