

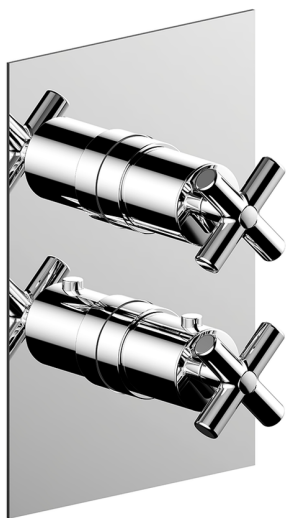



## Exposed part for Thermostatic One Box Valve ONE BOX\_SU0BT031



MODEL **SU0BT031**

Exposed part for Thermostatic One Box Valve, with 1-2-3 outlet devia stop, Minimum depth of installation: 67 mm, without concealed part, for items ZB00B030-ZB00B031

### AVAILABLE FINISHINGS

-  **21** 21 Chrome
-  **40** 40 Matt Black
-  **2F** 2F Brushed Nickel
-  **2W** 2W Brushed Gold

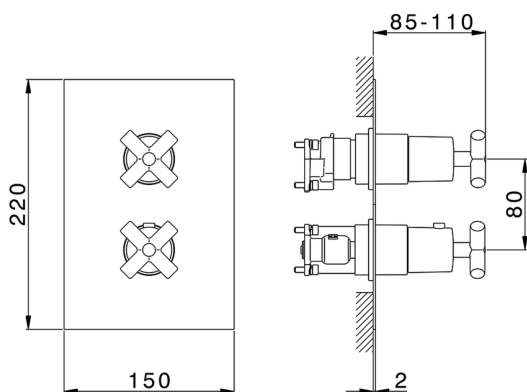

### CHARACTERISTICS

Cartridge Spare Parts **24.04A.PP**

**8x20 Plus P Thermostatic Valve**

Installation **Concealed**

Required concealed parts **ZB00B031**  
**ZB00B030**



### DeviaStop

The Huber Devia Stop technology allows to adjust the water flow and to direct it to the selected output point (overhead soaker, hand shower, etc).



### Thermostatic

The Huber thermostatic is your personal water manager, helping you to handle, control and save water and energy.



Exposed part for Thermostatic One Box Valve ONE BOX\_SU0BT031

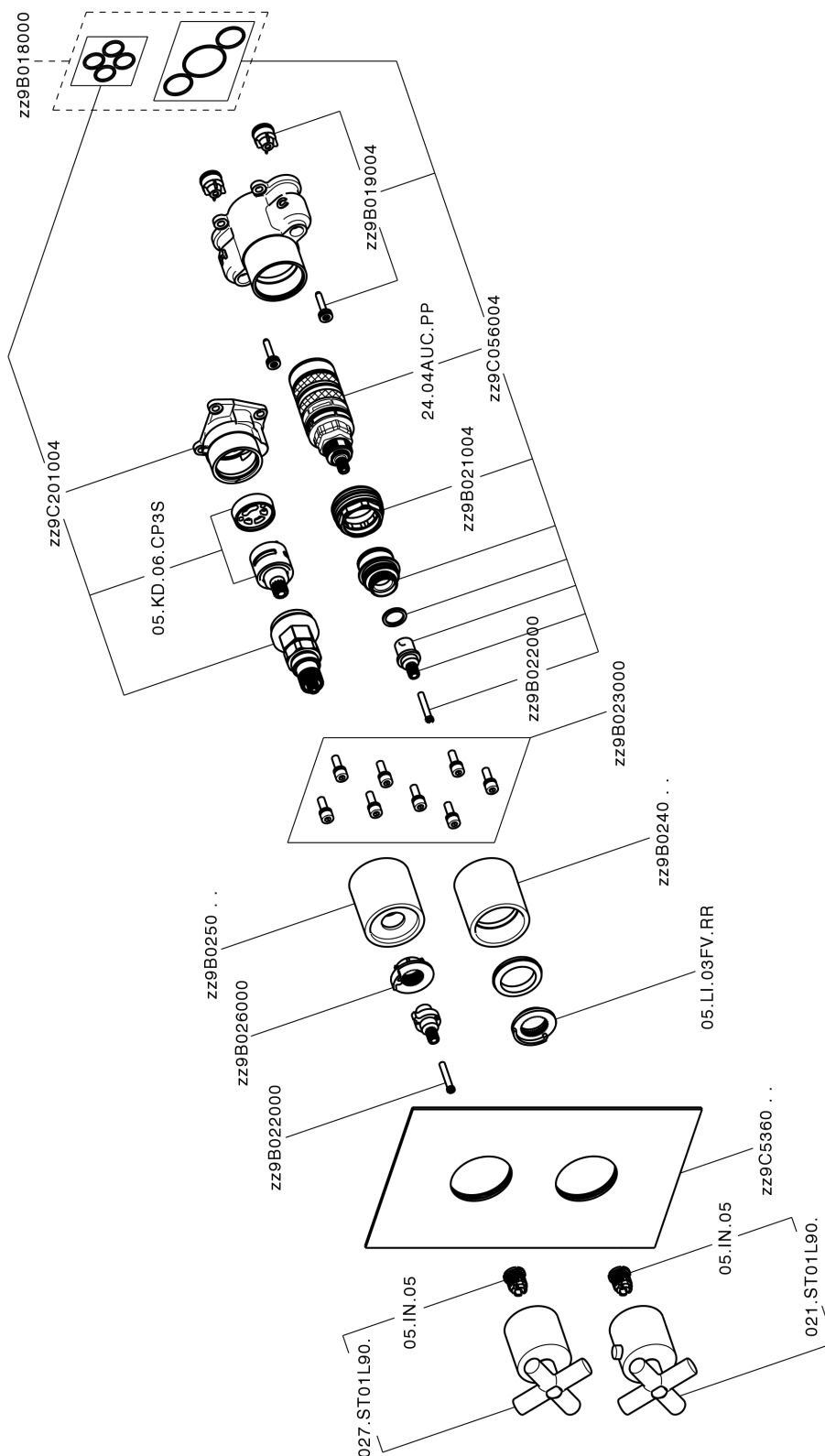

SU0BT031

<https://en.huberitalia.com/exposed-part-for-thermostatic-one-box-valve-one-box-su0bt031>

## One Box Universal Concealed Part ONE BOX\_ZB00B031



MODEL **ZB00B031**

One Box Universal Concealed Part, for 1 or 2 or 3 outlet thermostatic or single lever, without trim kit, with noise reducers, with sealing gasket

### AVAILABLE FINISHINGS



**04** 04 Without finishing

### CHARACTERISTICS

Concealed **1**  
Installation **Concealed**



### Thermostatic

The Huber thermostatic is your personal water manager, helping you to handle, control and save water and energy.



## One Box Universal Concealed Part ONE BOX\_ZB00B030

MODEL **ZB00B030**

One Box Universal Concealed Part, for 1 or 2 or 3 outlet thermostatic or single lever, without trim kit, without noise reducers, with sealing gasket

AVAILABLE FINISHINGS

 **04** 04 Without finishing

CHARACTERISTICS

Concealed **1**  
Installation **Concealed**



### Thermostatic

The Huber thermostatic is your personal water manager, helping you to handle, control and save water and energy.



2024-11-21