

Hanger CROISSETTE_4010.01H.

MODEL **4010.01H.**

Hanger



AVAILABLE FINISHINGS

-  **AC** AC Satin Brushed Nickel
-  **BA** BA Old Bronze
-  **CR** CR Chrome
-  **2W** 2W Brushed Gold

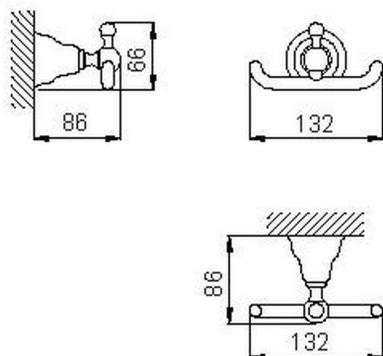

CHARACTERISTICS



2026-06-06