

## Exposed part for single lever washbasin valve LEVITY\_LY005511

MODEL **LY005511**

Exposed part for single lever washbasin valve, without concealed part, spout L.250 mm, for item Easy-Box ZB002450 and art. ZB025510

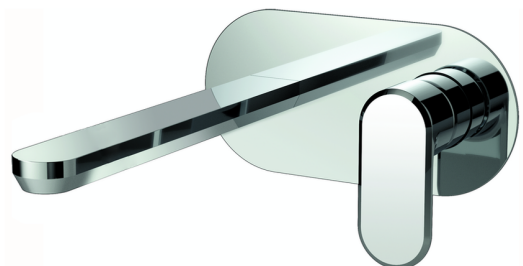

### AVAILABLE FINISHINGS

-  **21** 21 Chrome
-  **2B** 2B Polished Nickel
-  **2F** 2F Brushed Nickel
-  **40** 40 Matt Black
-  **4Q** 4Q Matt White

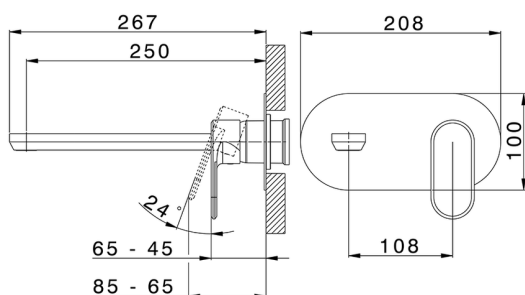

### CHARACTERISTICS

Installation **Concealed**  
 Required concealed parts **ZB002450**



## Exposed part for single lever washbasin valve LEVITY\_LY005511

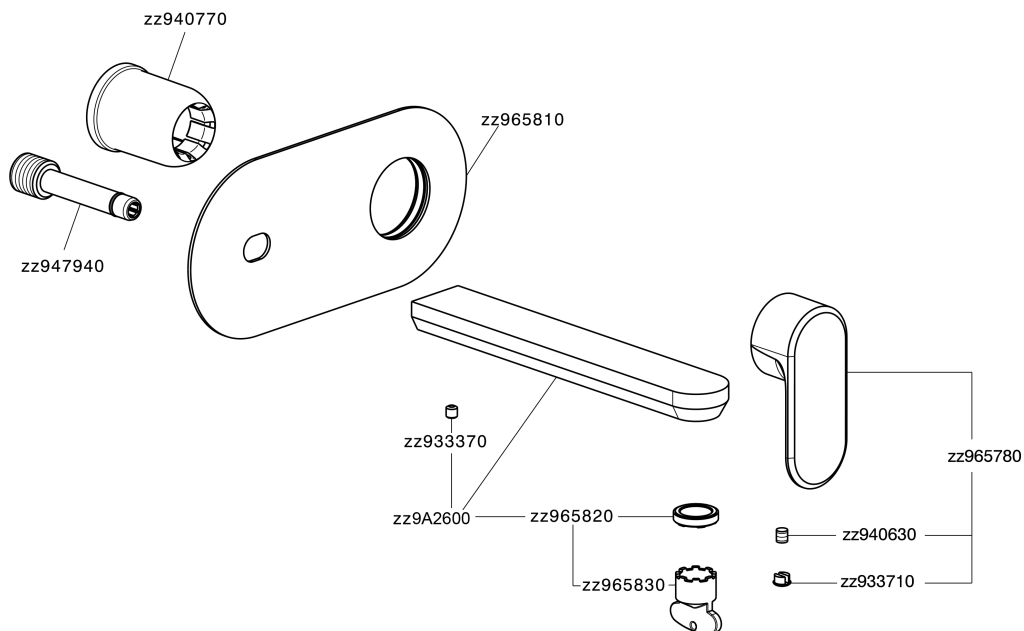

LY005511

<https://en.huberitalia.com/exposed-part-for-single-lever-washbasin-valve-levity-ly005511>

## Concealed single lever washbasin mixer Easy-Box CONCEALED\_ZB002450

MODEL **ZB002450**

Concealed single lever washbasin mixer  
Easy-Box, with protection guard box, without trim kit

AVAILABLE FINISHINGS



CHARACTERISTICS

Concealed **1**  
Cartridge Spare Parts **ZZ95409000**  
**35 mm Cartridge**



Piastra/Plate/Plaque/Platte/Placa

2-3mm: XX 56-76

10mm: XX 48-68



### EcoStop

EcoStop feature limits water flow to approximately 50% of maximum output with one point of resistance on setting. Push slightly past the middle stop only when full water output is required. This will save water up to 50%.



2024-12-22