





## Thermostatic shower mixer with sliding bar M32\_MTS01010

MODEL **MTS01010**

Thermostatic shower mixer with sliding bar, 60 cm slide rail kit with sliding bracket, 23 mm Brass One Spray handshower, 150 cm SUPREME smooth flexible hose

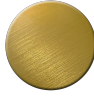
### AVAILABLE FINISHINGS

-  **21** 21 Chrome
-  **26** 26 Old Copper
-  **2F** 2F Brushed Nickel
-  **2W** 2W Brushed Gold
-  **40** 40 Matt Black
-  **4Q** 4Q Matt White

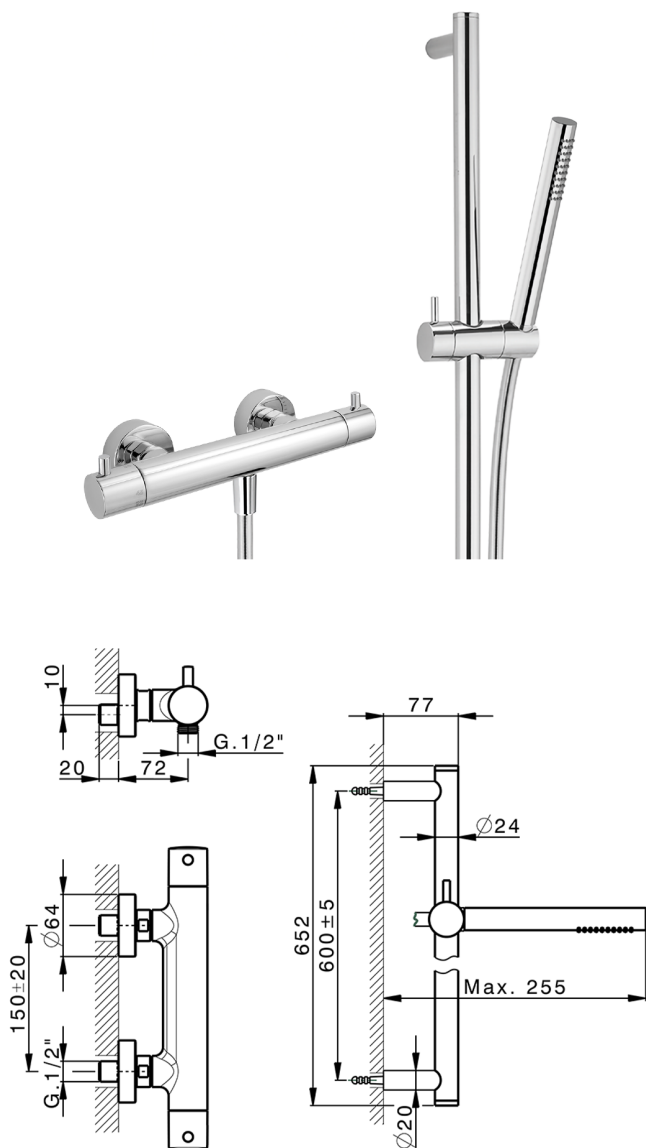

### CHARACTERISTICS

Cartridge Spare Parts **22.04A.AR - ZZ97279004**

**Argo 2 (long filter) Thermostatic Valve**



#### EcoStop

EcoStop feature limits water flow to approximately 50% of maximum output with one point of resistance on setting. Push slightly past the middle stop only when full water output is required. This will save water up to 50%.



#### SafeTouch

The Huber SafeTouch system maintains the mixer body cool to the touch during operation.



#### Thermostatic

The Huber thermostatic is your personal water manager, helping you to handle, control and save water and energy.



2024-12-19