





Single lever washbasin mixer DADO_DD000510



MODEL **DD000510**

Single lever washbasin mixer, with 1"1/4 automatic pop-up waste, G.3/8" stainless steel flexible hoses

AVAILABLE FINISHINGS

-  **21** 21 Chrome
-  **2B** 2B Polished Nickel
-  **2F** 2F Brushed Nickel
-  **40** 40 Matt Black
-  **4Q** 4Q Matt White

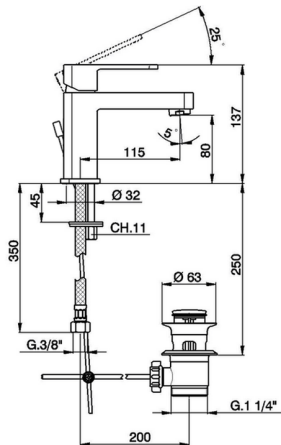

CHARACTERISTICS

Cartridge Spare Parts **ZZ94240000**

25 mm Cartridge



Single lever washbasin mixer DADO_DD000510

DD 00051 0

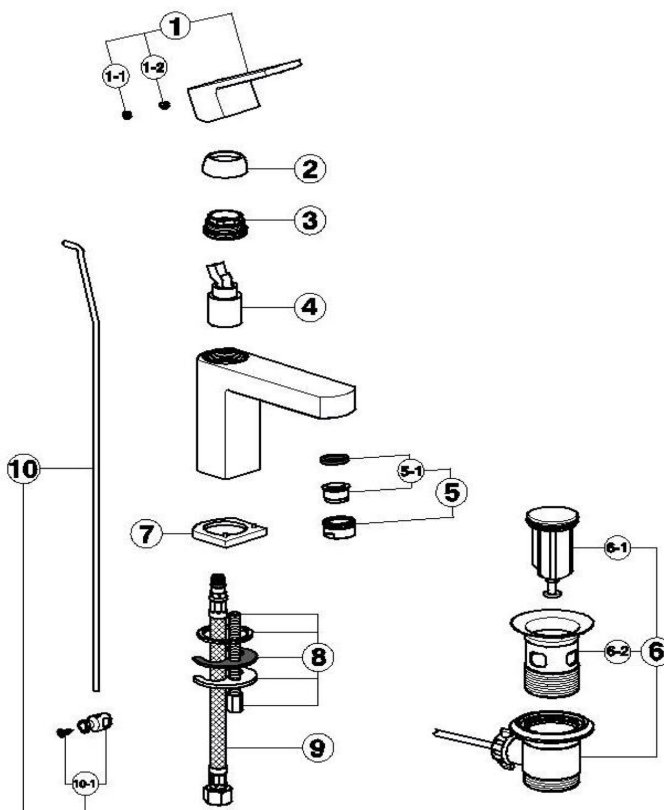
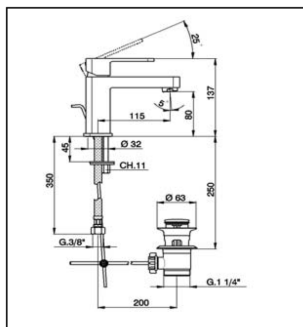

NR	DESCRIZIONE DESCRIPTION DESCRIPCION BESCHREIBUNG DESCRIPCION	N.CODICE NR.CODE CODE NO. WERSKNR. N.CÓDIGO
1	Leva monocomando "DD" Lever "DD" Hebel "DD" Palanca monomando "DD" Placchetta maniglia LS Plaque cache - vis crois LS Abdeckkappe LS Griff Plaquita maneta LS	ZZ955930
1-1	Grano punta coppa inox M.5x6 Vis speciale inox M.5x6 1-2 Screw-stainless steel M.5x6 Madenschraube M.5x6 Clavija con punta copa acero inox M.5x6	ZZ940630
2	Copricartuccia monocomando Couvre-cartouche Escutcheon cartridge Abdeckkappe Cubre-cartucho monomando Calotta bloccaggio cartuccia Ecrou pour cartouche	ZZ955210
3	Nut for mixing valve Mutter fuer Kartusche Casquete de fijación cartucho Cartuccia monocomando Cartouche mitigeurs	ZZ955220
4	Mixing valve Kartusche Cartucho monomando	ZZ942400

NR	DESCRIZIONE DESCRIPTION DESCRIPCION BESCHREIBUNG DESCRIPCION	N.CODICE NR.CODE CODE NO. WERSKNR. N.CÓDIGO
5	Aeratore M24x1 IA Cascade Mousseur M24x1 IA Cascade Mousseur M24x1 IA Cascade Perlator M24x1 IA Cascade Aireador M24x1 IA Cascade	ZZ944150
5-1	Cartuccia per aeratore M.24x1 Cascade Cartouche pour mousseur M.24x1 Cascade Mousseur cartridge M.24x1 Cascade Kartusche fuer Perlator M.24x1 Cascade Cartucho para aireador M.24x1 Cascade	ZZ933390
6	Scarico automatico 1"1/4 sabbato Vidage automatique 1"1/4 sabbato Pop up waste 1"1/4 sabbato Ablaufgarnitur 1"1/4 sabbato Desagüe automático 1"1/4 arenado	ZZ927540
6-1	Tappo completo scarico automatico 1"1/4 Bonde-vidage 1"1/4 Plug for pop up waste 1"1/4 Stopfen fuer Ablaufgarnitur kpl 1"1/4 Tapón completo columna desagüe automático 1"1	ZZ929250
6-2	Piletta per scarico automatico 1"1/4 Crépine pour vidage 1"1/4 Waste for bath drain 1"1/4 Ablauf fuer Ablaufgarnitur 1"1/4 Válvula para desagüe automático 1"1/4	ZZ929240
7	Basetta monocomando "DD" Bague "DD" Assembling ring "DD" Basis "DD" Base monomando lavabo "DD"	ZZ955230

NR	DESCRIZIONE DESCRIPTION DESCRIPCION BESCHREIBUNG DESCRIPCION	N.CODICE NR.CODE CODE NO. WERSKNR. N.CÓDIGO
8	Set installazione monocomando monoforo Set installation Installation set single hole Befestigungsset Juego de instalación monomando	ZZ940690
9	Flex M10x1-G3/8" L.420 Flex M10x1-G3/8" L.420 Flex M10x1-G3/8" L.420 Anschluss Schlauch M10x1-G3/8" L.420 Flexo M10x1-G3/8" L.420	ZZ954110
10	Astina scarico completa Ø 4 Tige Ø4 Rod Ø4	ZZ933400
10-1	Morsetto astina scarico automatico Jonction pour tige vidage Connection for pop-up rod Gelenstueck fuer Zugstange Abrazadera varilla desagüe automático	ZZ933430

DD000510

<https://en.huberitalia.com/single-lever-washbasin-mixer-dado-dd000510>

2024-11-23