

## Cover Part for 2 Function Concealed Thermo Valve NUOVA KIRUNA\_K201R200

MODEL **K201R200**

Cover Part for 2 Function Concealed Thermo Valve, for item ZB01R200

### AVAILABLE FINISHINGS

-  **21** 21 Chrome
-  **26** 26 Old Copper
-  **2F** 2F Brushed Nickel
-  **2W** 2W Brushed Gold
-  **40** 40 Matt Black
-  **4Q** 4Q Matt White

### CHARACTERISTICS

Installation **Concealed**  
 Required concealed parts **ZB01R200**

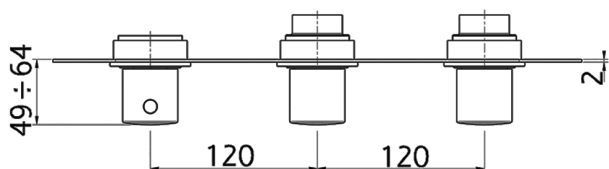
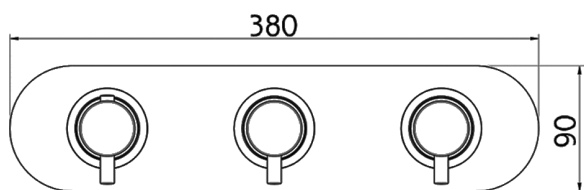
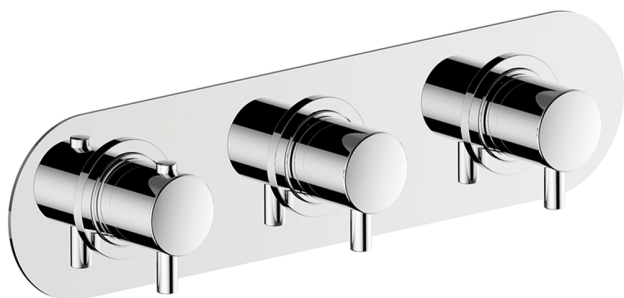

### Thermostatic

The Huber thermostatic is your personal water manager, helping you to handle, control and save water and energy.



## 2 Function Concealed Thermostatic Valve CONCEALED\_ZB01R200

MODEL **ZB01R200**

2 Function Concealed Thermostatic Valve

AVAILABLE FINISHINGS

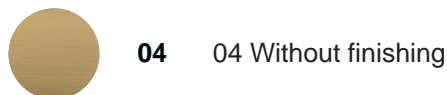

CHARACTERISTICS

Installation	<b>Concealed</b>
Cartridge Spare Parts	<b>23.51A.HF</b>
<b>HF Thermostatic Valve</b>	
Concealed	<b>1</b>

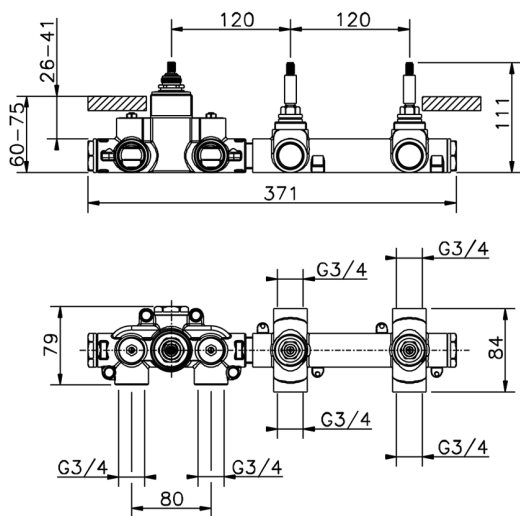

### Thermostatic

The Huber thermostatic is your personal water manager, helping you to handle, control and save water and energy.



2026-05-25