

Single lever washbasin mixer EnergySave BACCARAT_BC000515

MODEL **BC000515**

Single lever washbasin mixer EnergySave, with 1"1/4 automatic pop-up waste, G.3/8" stainless steel flexible hoses



AVAILABLE FINISHINGS



CHARACTERISTICS

Cartridge Spare Parts **ZZ96420000**

40 mm Cartridge

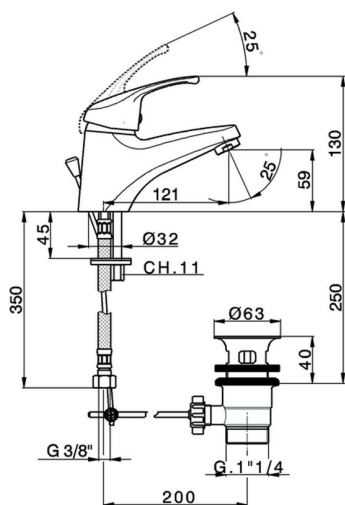

EnergySave

Thanks to the EnergySave device, only cold water will be drawn if the lever is operated in the central position, so that the water heater will not be engaged and no hot water wasted, leading to considerable savings in energy and costs. The temperature can be adjusted by rotating the lever to the left, until the desired temperature is reached.



Single lever washbasin mixer EnergySave BACCARAT_BC000515

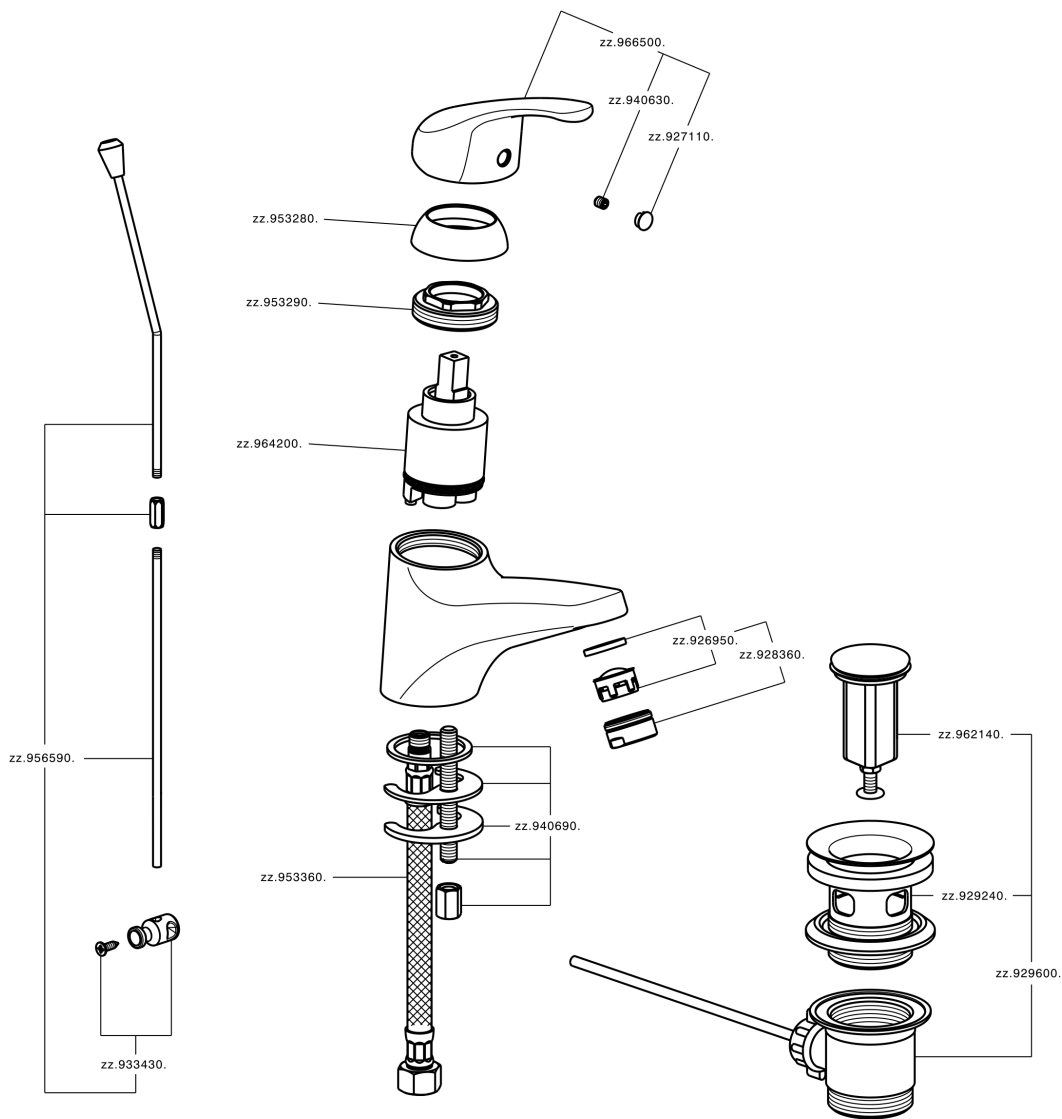

BC000515

<https://en.huberitalia.com/single-lever-washbasin-mixer-energysave-baccarat-bc000515>

2026-06-05