







1" 1/4 waste for basin mixer COMPONENTS_ZB001610

MODEL **ZB001610**

1" 1/4 waste for basin mixer, always open, for bath drain system without overflow, for thickness max 50 mm



AVAILABLE FINISHINGS

-  **21** 21 Chrome
-  **2F** 2F Brushed Nickel
-  **2P** 2P Rose Gold
-  **40** 40 Matt Black
-  **4Q** 4Q Matt White
-  **2B** 2B Polished Nickel

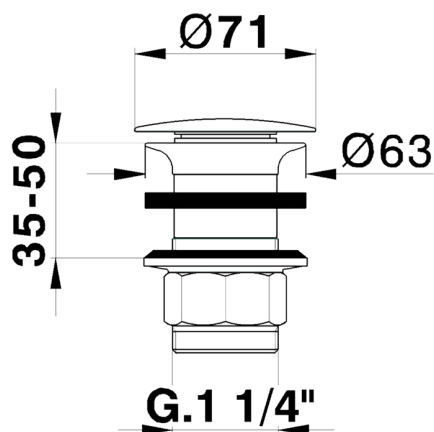

CHARACTERISTICS



2026-06-13