

## Exposed part for con.thermo.shower valve, 2-outlet THERMO\_K2018100

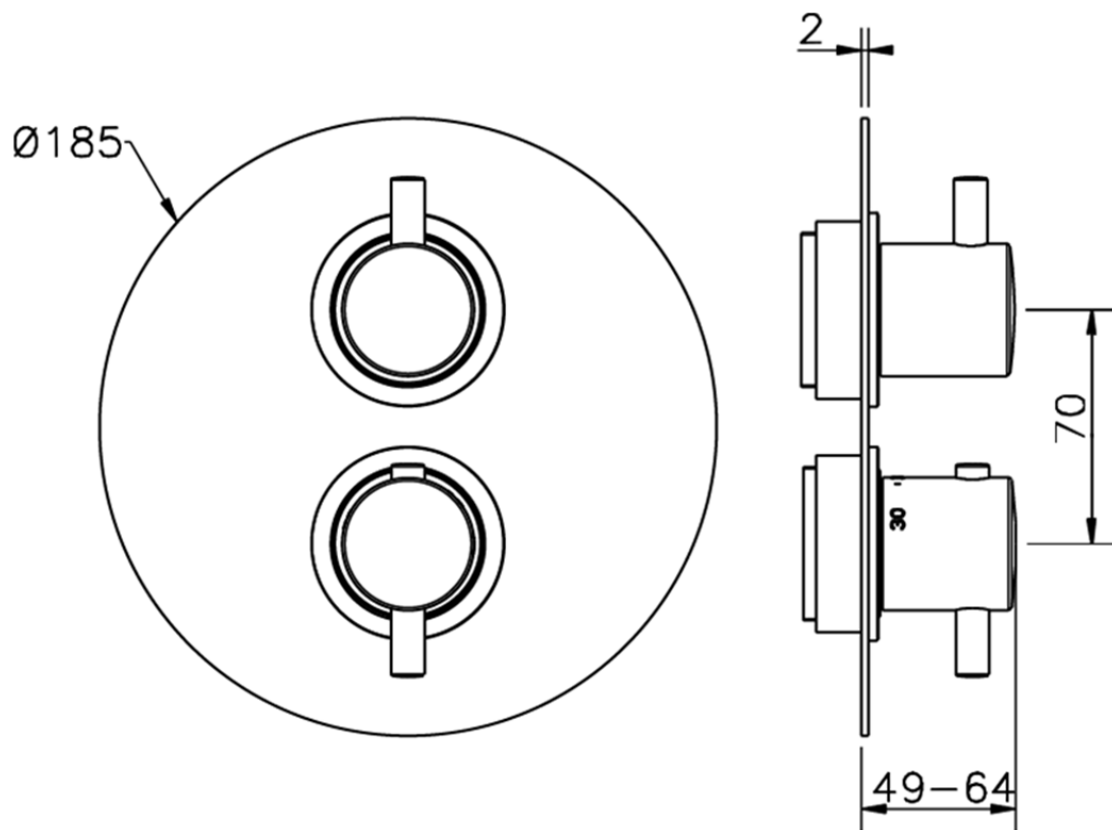

K2018100

<https://en.huberitalia.com/exposed-part-for-con-thermo-shower-valve-2-outlet-thermo-k2018100>



## Piastra/Plate/Plaque/Platte/Placa

2-3mm: XX 25-40 YY 76-91

10 mm: XX 16-31 YY 65-80

ZB018101

<https://en.huberitalia.com/2-outlet-concealed-thermostatic-shower-valve-concealed-zb018101>

2024-11-14