





Exposed part for Single Lever One Box Valve LEVITY_LY0BM010

MODEL **LY0BM010**

Exposed part for Single Lever One Box Valve, 1 Outlet, Minimum depth of installation: 67 mm, without concealed part, for items ZB00B030-ZB00B031

AVAILABLE FINISHINGS

-  **21** 21 Chrome
-  **2B** 2B Polished Nickel
-  **2F** 2F Brushed Nickel
-  **40** 40 Matt Black
-  **4Q** 4Q Matt White

CHARACTERISTICS

Cartridge Spare Parts **ZZ97179000**
35 mm Cartridge
 Installation **Concealed**
 Required concealed parts **ZB00B031**
ZB00B030

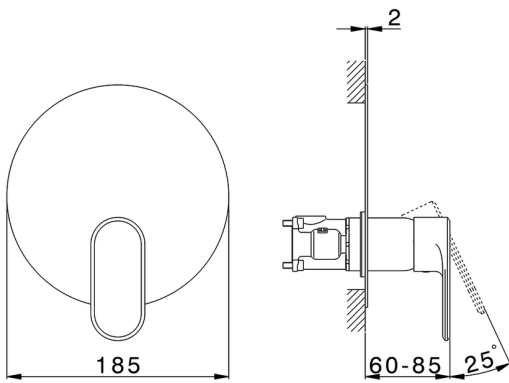

Exposed part for Single Lever One Box Valve LEVITY_LY0BM010

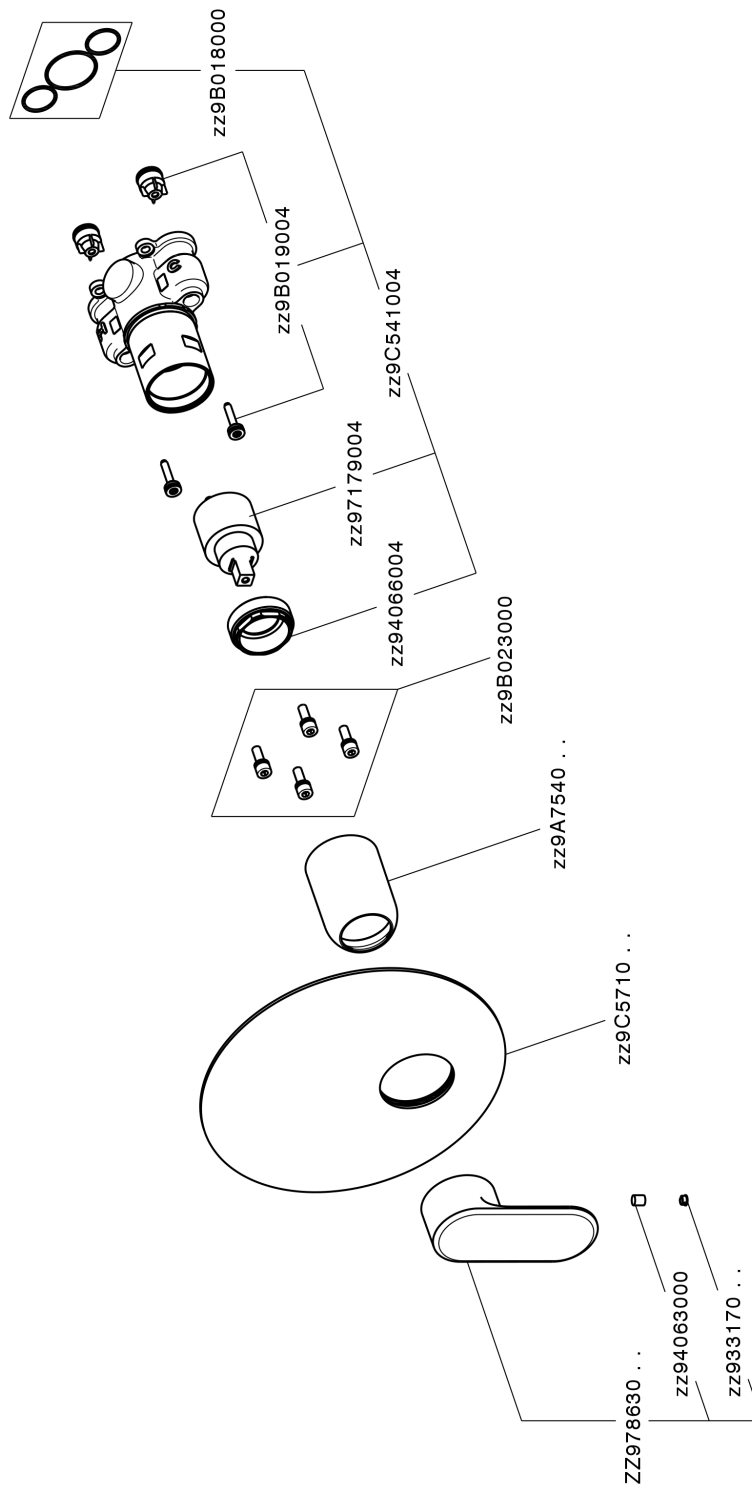

LY0BM010

<https://en.huberitalia.com/exposed-part-for-single-lever-one-box-valve-levity-ly0bm010>

One Box Universal Concealed Part ONE BOX_ZB00B031



MODEL **ZB00B031**

One Box Universal Concealed Part, for 1 or 2 or 3 outlet thermostatic or single lever, without trim kit, with noise reducers, with sealing gasket

AVAILABLE FINISHINGS



CHARACTERISTICS

Concealed **1**
Installation **Concealed**



Thermostatic

The Huber thermostatic is your personal water manager, helping you to handle, control and save water and energy.



One Box Universal Concealed Part ONE BOX_ZB00B030

MODEL **ZB00B030**

One Box Universal Concealed Part, for 1 or 2 or 3 outlet thermostatic or single lever, without trim kit, without noise reducers, with sealing gasket

AVAILABLE FINISHINGS

 **04** 04 Without finishing

CHARACTERISTICS

Concealed **1**
Installation **Concealed**



Thermostatic

The Huber thermostatic is your personal water manager, helping you to handle, control and save water and energy.



2024-11-15