







## Thermostatic bath-shower mixer with sliding bar M32\_MTS23016

MODEL **MTS23016**

Thermostatic bath-shower mixer with sliding bar, 60 cm slide rail kit with sliding bracket, 23 mm Brass One Spray handshower, 150 cm SUPREME smooth flexible hose

### AVAILABLE FINISHINGS

-  **21** 21 Chrome
-  **26** 26 Old Copper
-  **2F** 2F Brushed Nickel
-  **2W** 2W Brushed Gold
-  **40** 40 Matt Black
-  **4Q** 4Q Matt White

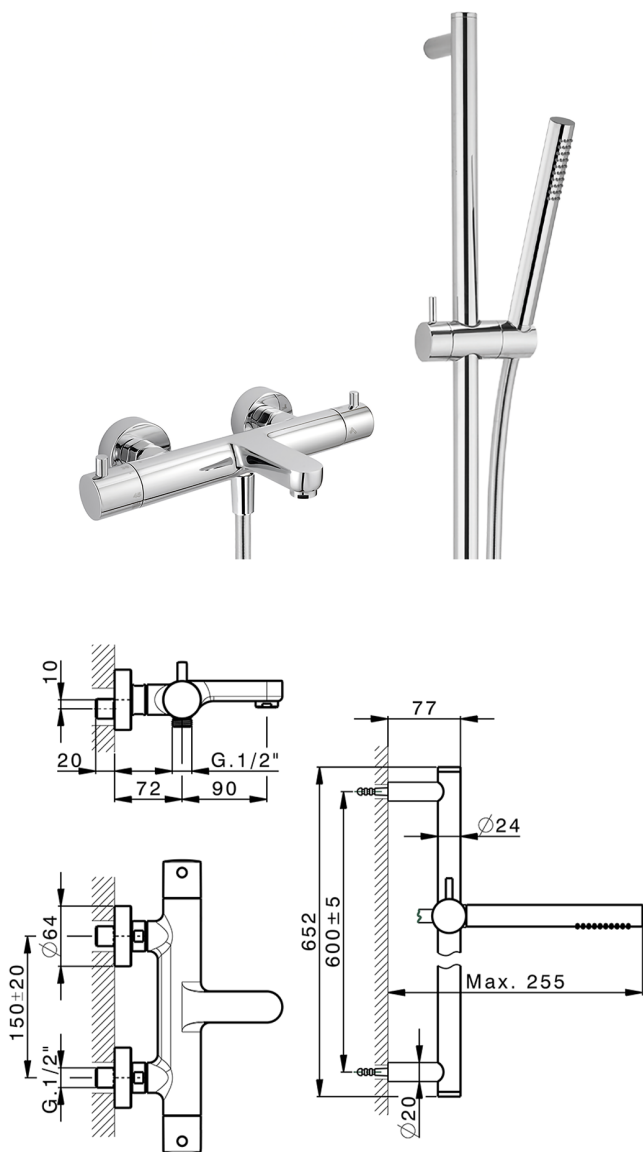

### CHARACTERISTICS

Cartridge Spare Parts **22.04A.AR - ZZ97279004**

**Argo 2 (long filter) Thermostatic Valve**



#### DeviaStop

The Huber Devia Stop technology allows to adjust the water flow and to direct it to the selected output point (overhead soaker, hand shower, etc).



#### SafeTouch

The Huber SafeTouch system maintains the mixer body cool to the touch during operation.



#### Thermostatic

The Huber thermostatic is your personal water manager, helping you to handle, control and save water and energy.



2026-04-08