



## Exposed part for concealed S.L. shower valve **CHRONOS\_CR003000**

MODEL **CR003000**

Exposed part for concealed S.L. shower valve, without concealed part, for item ZB005300 - ZB005301

### AVAILABLE FINISHINGS

-  **21** 21 Chrome
-  **2F** 2F Brushed Nickel
-  **2Q** 2Q Black Titanium

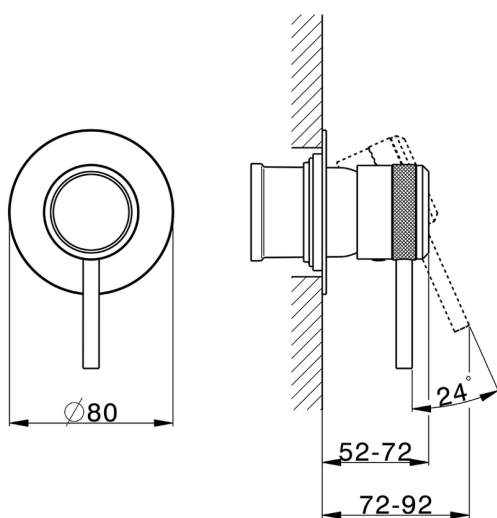

### CHARACTERISTICS

Installation **Concealed**

Required concealed parts **ZB005301**

**ZB005300**



## Exposed part for concealed S.L. shower valve CHRONOS\_CR003000

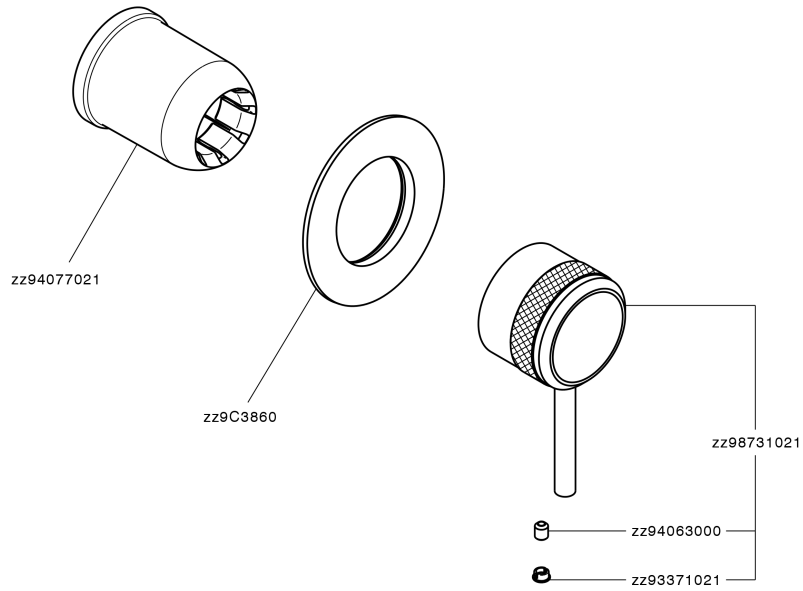

CR003000

<https://en.huberitalia.com/exposed-part-for-concealed-s-l-shower-valve-chronos-cr003000>

## Concealed single lever shower mixer CONCEALED\_ZB005301



MODEL **ZB005301**

Concealed single lever shower mixer, 1/2" concealed shower, without trim kit, with noise reducers

AVAILABLE FINISHINGS



**04** 04 Without finishing

CHARACTERISTICS

Installation	<b>Concealed</b>
Cartridge Spare Parts	<b>ZZ94035000</b>
<b>35 mm Cartridge</b>	
Concealed	<b>1</b>

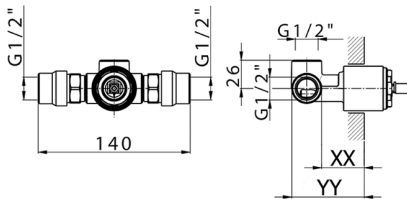

Piastra/Plate/Plaque/Platte/Placa  
 2-3mm: XX 27-47 YY 54-74  
 10mm: XX 16-40 YY 43-68



**Concealed single lever shower valve CONCEALED\_ZB005300**

MODEL **ZB005300**

Concealed single lever shower valve, 1/2" Concealed shower mixer, without trim kit



AVAILABLE FINISHINGS

 **04** 04 Without finishing

CHARACTERISTICS

Installation	<b>Concealed</b>
Cartridge Spare Parts	<b>ZZ94035000</b>
<b>35 mm Cartridge</b>	
Concealed	<b>1</b>

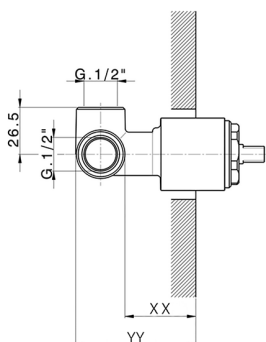

Piastra/Plate/Plaque/Platte/Placa  
 2-3mm: XX 27-47 YY 54-74  
 10mm: XX 16-40 YY 43-68



2024-11-23