

Concealed single lever bath-shower valve SATURNO_SN000219



MODEL **SN000219**

Concealed single lever bath-shower valve, with concealed part, 2-outlet automatic diverter

AVAILABLE FINISHINGS



CHARACTERISTICS

Cartridge Spare Parts **ZZ94035000**

35 mm Cartridge

Installation **Concealed**

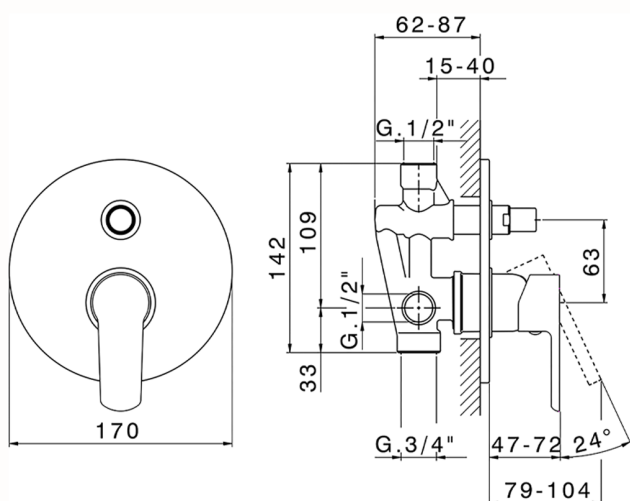

Concealed single lever bath-shower valve SATURNO_SN000219

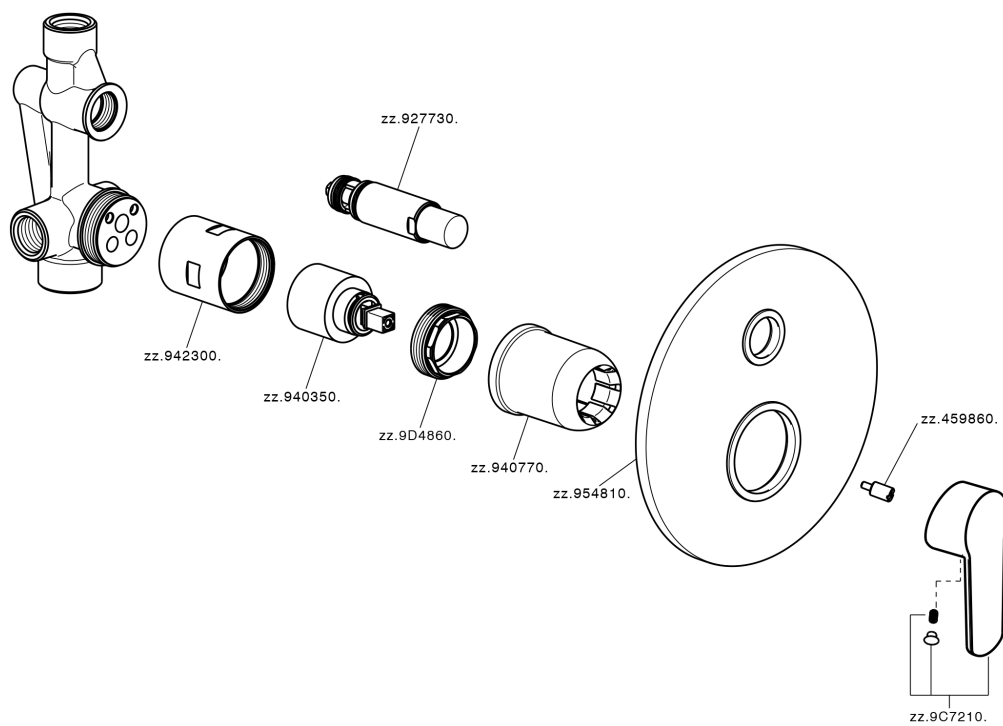

SN000219

<https://en.huberitalia.com/concealed-single-lever-bath-shower-valve-saturno-sn000219>

2026-04-27