





Exposed part for single lever washbasin valve NUOVA EGO_NE005511

MODEL **NE005511**

Exposed part for single lever washbasin valve, without concealed part, spout L.250 mm, for item Easy-Box ZB002450 and art. ZB025510

AVAILABLE FINISHINGS

-  **21** 21 Chrome
-  **2F** 2F Brushed Nickel
-  **40** 40 Matt Black
-  **4Q** 4Q Matt White

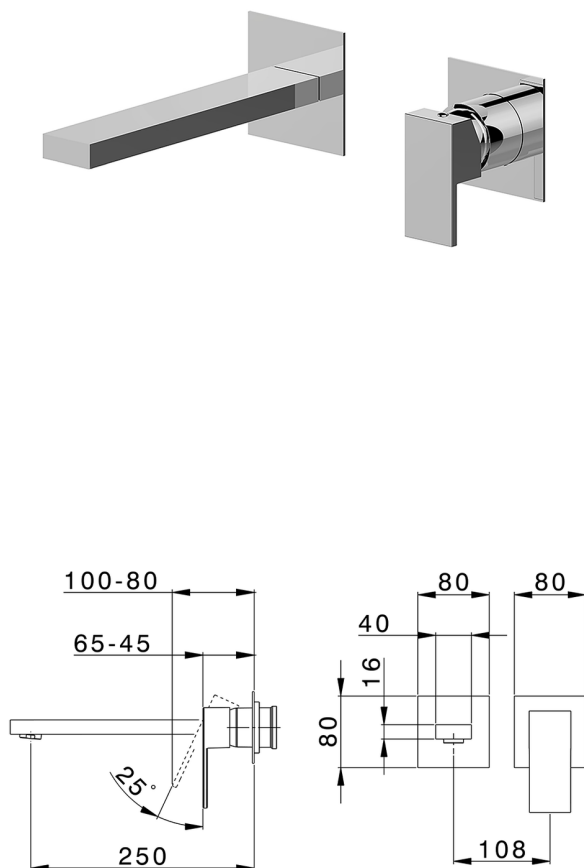

CHARACTERISTICS

Installation **Concealed**
 Required concealed parts **ZB002450**



Concealed single lever washbasin mixer Easy-Box CONCEALED_ZB002450

MODEL **ZB002450**

Concealed single lever washbasin mixer
Easy-Box, with protection guard box, without trim kit

AVAILABLE FINISHINGS

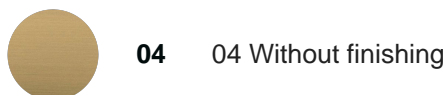

CHARACTERISTICS

Concealed **1**
Cartridge Spare Parts **ZZ95409000**
35 mm Cartridge

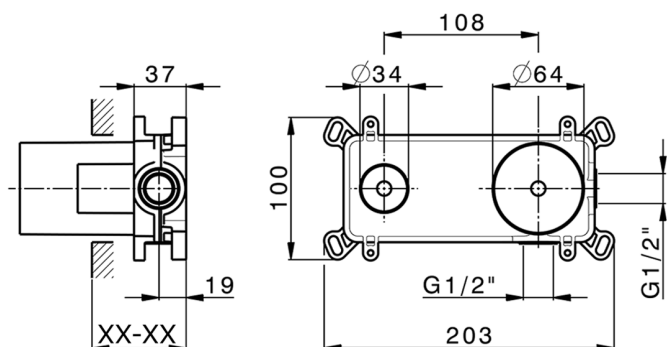
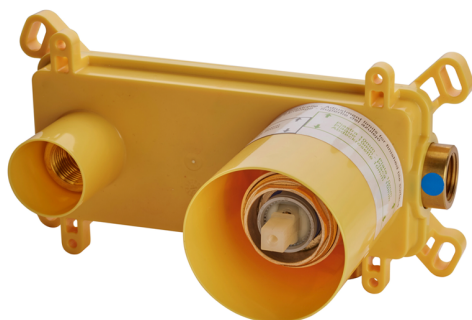

Piastra/Plate/Plaque/Platte/Placa

2-3mm: XX 56-76

10mm: XX 48-68



EcoStop

EcoStop feature limits water flow to approximately 50% of maximum output with one point of resistance on setting. Push slightly past the middle stop only when full water output is required. This will save water up to 50%.



2025-01-05