

Exposed part for con thermo shower valve, 2-outlet THERMO_DD018100

MODEL **DD018100**

Exposed part for 2-outlet thermostatic mixer, with 2 outlet diverter, without concealed part, for item ZB018101

AVAILABLE FINISHINGS

-  **21** 21 Chrome
-  **2B** 2B Polished Nickel
-  **2F** 2F Brushed Nickel
-  **40** 40 Matt Black
-  **4Q** 4Q Matt White

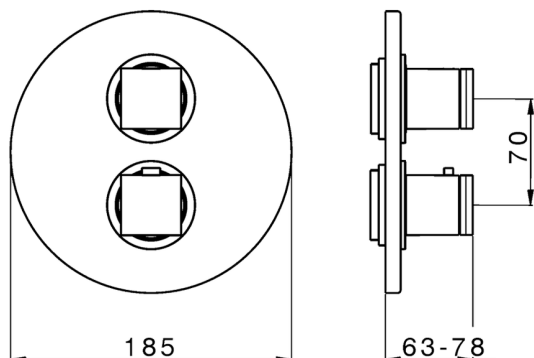

CHARACTERISTICS

Installation **Concealed**
 Required concealed parts **ZB018101**



Thermostatic

The Huber thermostatic is your personal water manager, helping you to handle, control and save water and energy.



2-outlet Concealed thermostatic shower valve CONCEALED_ZB018101

MODEL **ZB018101**

2-outlet Concealed thermostatic mixer, with 2-outlet diverter, without trim kit

AVAILABLE FINISHINGS



CHARACTERISTICS

Installation	Concealed
Cartridge Spare Parts	24.04A.PP
8x20 Plus P Thermostatic Valve	
Concealed	1



Piastra/Plate/Plaque/Platte/Placa

2-3mm: XX 25-40 YY 76-91

10 mm: XX 16-31 YY 65-80



DeviaStop

The Huber Devia Stop technology allows to adjust the water flow and to direct it to the selected output point (overhead soaker, hand shower, etc).



Thermostatic

The Huber thermostatic is your personal water manager, helping you to handle, control and save water and energy.



2026-04-29