

## Shower arm with VT-CS showerhead SHOWER\_611.02H.

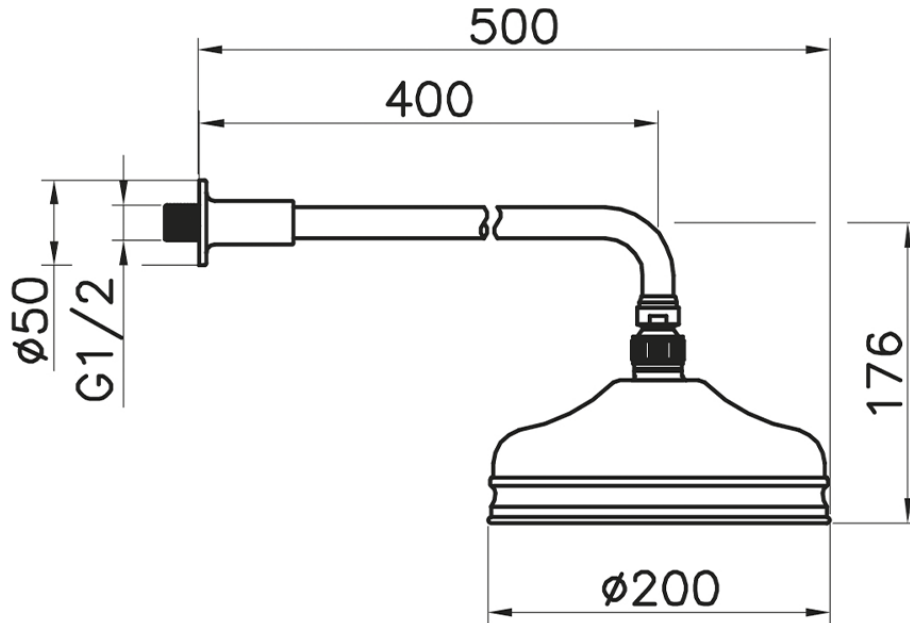

611.02H.

<https://en.huberitalia.com/shower-arm-with-vt-cs-showerhead-shower-611-02h>

2024-11-15