





Thermostatic shower mixer with sliding bar M32_MTS01010

MODEL **MTS01010**

Thermostatic shower mixer with sliding bar, 60 cm slide rail kit with sliding bracket, 23 mm Brass One Spray handshower, 150 cm SUPREME smooth flexible hose

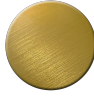
AVAILABLE FINISHINGS

-  **21** 21 Chrome
-  **26** 26 Old Copper
-  **2F** 2F Brushed Nickel
-  **2W** 2W Brushed Gold
-  **40** 40 Matt Black
-  **4Q** 4Q Matt White

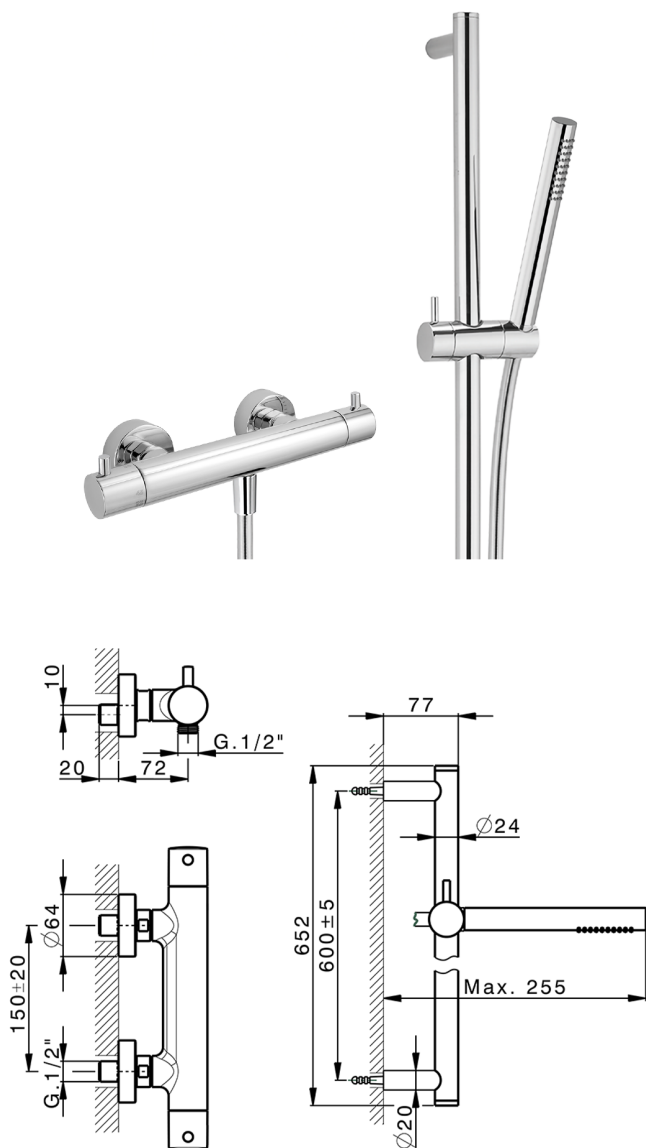

CHARACTERISTICS

Cartridge Spare Parts **22.04A.AR - ZZ97279004**

Argo 2 (long filter) Thermostatic Valve



EcoStop

EcoStop feature limits water flow to approximately 50% of maximum output with one point of resistance on setting. Push slightly past the middle stop only when full water output is required. This will save water up to 50%.



SafeTouch

The Huber SafeTouch system maintains the mixer body cool to the touch during operation.



Thermostatic

The Huber thermostatic is your personal water manager, helping you to handle, control and save water and energy.



2024-11-12