

## Exposed part for con.thermo.shower valve, 2-outlet NUOVA KIRUNA\_K2018100

MODEL **K2018100**

Exposed part for 2-outlet thermostatic mixer, with 2-outlet diverter, without concealed part, for item ZB018101

### AVAILABLE FINISHINGS

-  **21** 21 Chrome
-  **26** 26 Old Copper
-  **2F** 2F Brushed Nickel
-  **2W** 2W Brushed Gold
-  **40** 40 Matt Black
-  **4Q** 4Q Matt White

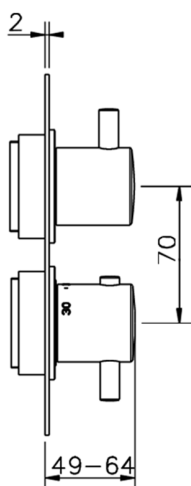
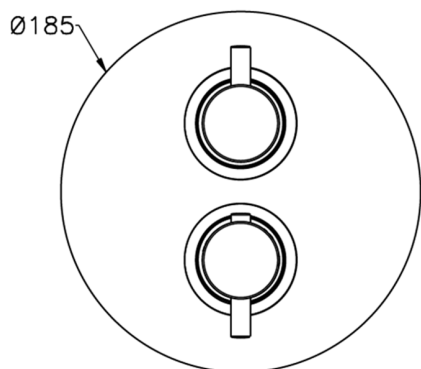

### CHARACTERISTICS

Installation **Concealed**  
 Required concealed parts **ZB018101**



### Thermostatic

The Huber thermostatic is your personal water manager, helping you to handle, control and save water and energy.



## 2-outlet Concealed thermostatic shower valve CONCEALED\_ZB018101

MODEL **ZB018101**

2-outlet Concealed thermostatic mixer, with 2-outlet diverter, without trim kit

AVAILABLE FINISHINGS



**04** 04 Without finishing



CHARACTERISTICS

Installation **Concealed**

Cartridge Spare Parts **24.04A.PP**

**8x20 Plus P Thermostatic Valve**

Concealed **1**

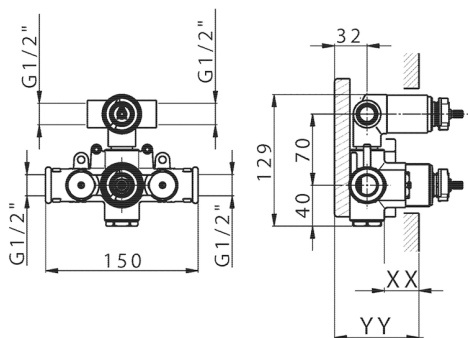

Piastra/Plate/Plaque/Platte/Placa

2-3mm: XX 25-40 YY 76-91

10 mm: XX 16-31 YY 65-80



### DeviaStop

The Huber Devia Stop technology allows to adjust the water flow and to direct it to the selected output point (overhead soaker, hand shower, etc).



### Thermostatic

The Huber thermostatic is your personal water manager, helping you to handle, control and save water and energy.



2026-04-09