

Pillar tap CROISETTE_CS000900

MODEL **CS000900**

Pillar tap, without automatic pop-up waste



AVAILABLE FINISHINGS

-  **21** 21 Chrome
-  **2G** 2G Antique Gold
-  **2W** 2W Brushed Gold

CHARACTERISTICS

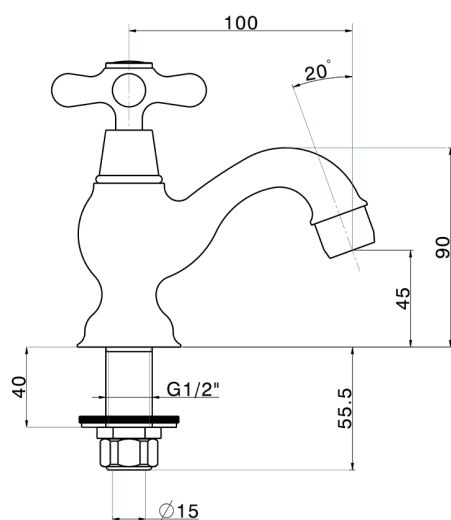

Pillar tap CROISSETTE_CS000900

PL.21 

GH.01 

VI.05 

RA.07 

CC.08 

CP.27 

ZZ.929070 

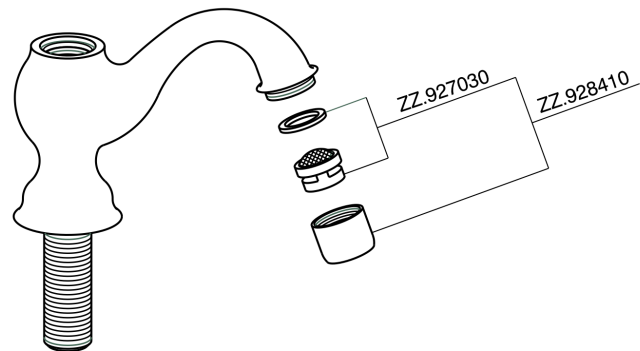

GG.06 

KF.09  DS.02

DD.05 

CA.23 

CS000900

<https://en.huberitalia.com/pillar-tap-croisette-cs000900>

2024-12-19