



Pillar tap CROISETTE_CS000900

MODEL **CS000900**

Pillar tap, without automatic pop-up waste



AVAILABLE FINISHINGS

- 
21 21 Chrome
- 
2G 2G Antique Gold
- 
2W 2W Brushed Gold

CHARACTERISTICS

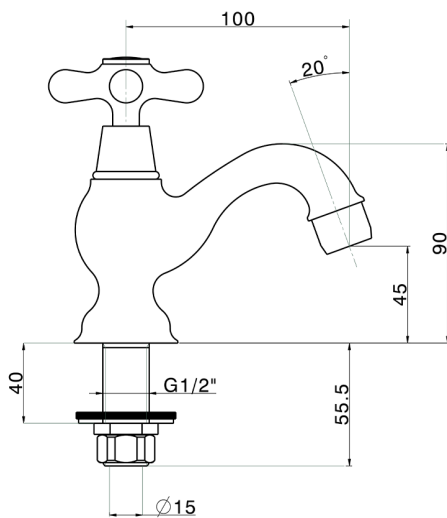

Pillar tap CROISSETTE_CS000900

PL.21 

GH.01 

VI.05 

RA.07 

CC.08 

CP.27 

ZZ.929070 

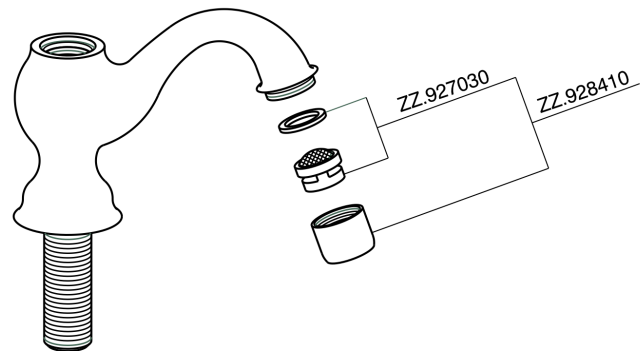

GG.06 

KF.09  DS.02

DD.05 

CA.23 

CS000900

<https://en.huberitalia.com/pillar-tap-croisette-cs000900>

2025-01-05