







## Exposed part for concealed S.L. shower valve NUOVA KIRUNA\_K2003000

MODEL **K2003000**

Exposed part for concealed S.L. shower valve, without concealed part, for item ZB005300-ZB005301

### AVAILABLE FINISHINGS

-  **21** 21 Chrome
-  **26** 26 Old Copper
-  **2F** 2F Brushed Nickel
-  **2W** 2W Brushed Gold
-  **40** 40 Matt Black
-  **4Q** 4Q Matt White

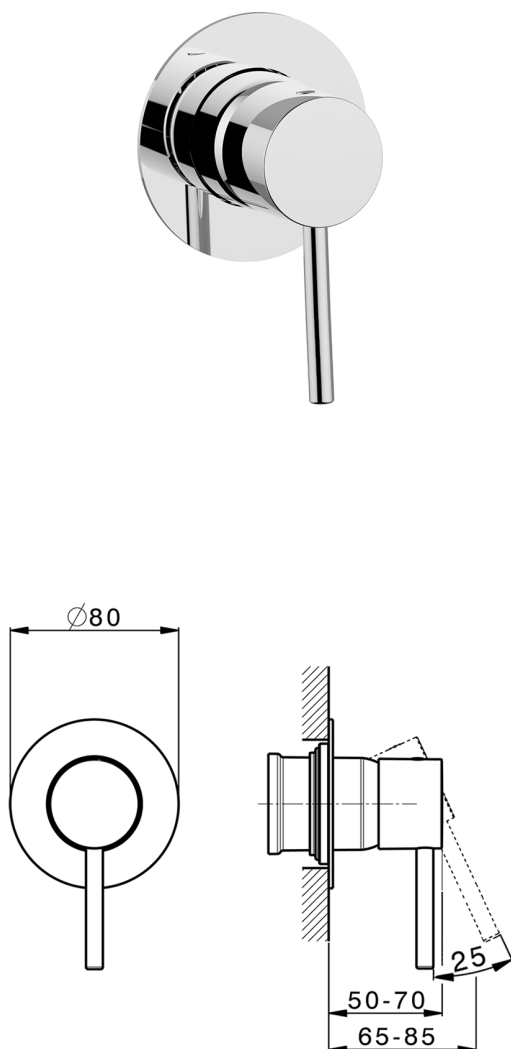

### CHARACTERISTICS

Installation **Concealed**  
 Required concealed parts **ZB005301**  
**ZB005300**



## Concealed single lever shower mixer CONCEALED\_ZB005301



MODEL **ZB005301**

Concealed single lever shower mixer, 1/2" concealed shower, without trim kit, with noise reducers

AVAILABLE FINISHINGS



**04** 04 Without finishing

CHARACTERISTICS

Installation	<b>Concealed</b>
Cartridge Spare Parts	<b>ZZ94035000</b>
<b>35 mm Cartridge</b>	
Concealed	<b>1</b>

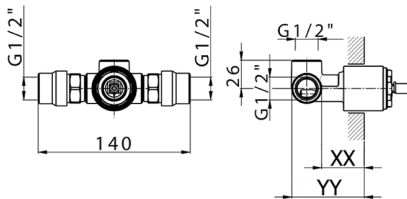

Piastra/Plate/Plaque/Platte/Placa  
 2-3mm: XX 27-47 YY 54-74  
 10mm: XX 16-40 YY 43-68



## Concealed single lever shower valve CONCEALED\_ZB005300

MODEL **ZB005300**

Concealed single lever shower valve, 1/2" Concealed shower mixer, without trim kit



AVAILABLE FINISHINGS



**04** 04 Without finishing

CHARACTERISTICS

Installation	<b>Concealed</b>
Cartridge Spare Parts	<b>ZZ94035000</b>
<b>35 mm Cartridge</b>	
Concealed	<b>1</b>

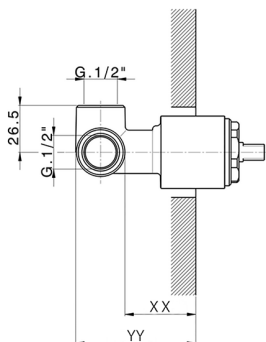

Piastra/Plate/Plaque/Platte/Placa  
 2-3mm: XX 27-47 YY 54-74  
 10mm: XX 16-40 YY 43-68



2024-09-20