

## Exposed part for Thermostatic One Box Valve LEVITY\_LY0BT030



MODEL **LY0BT030**

Exposed part for Thermostatic One Box Valve, with 1-2-3 outlet devia stop, Minimum depth of installation: 67 mm, without concealed part, for items ZB00B030-ZB00B031

### AVAILABLE FINISHINGS

-  **21** 21 Chrome
-  **2B** 2B Polished Nickel
-  **2F** 2F Brushed Nickel
-  **40** 40 Matt Black
-  **4Q** 4Q Matt White

### CHARACTERISTICS

Cartridge Spare Parts **24.04A.PP**

**8x20 Plus P Thermostatic Valve**

Installation **Concealed**

Required concealed parts **ZB00B031**

**ZB00B030**



### DeviaStop

The Huber Devia Stop technology allows to adjust the water flow and to direct it to the selected output point (overhead soaker, hand shower, etc).



### Thermostatic

The Huber thermostatic is your personal water manager, helping you to handle, control and save water and energy.



## Exposed part for Thermostatic One Box Valve LEVITY\_LY0BT030



LY0BT030

<https://en.huberitalia.com/exposed-part-for-thermostatic-one-box-valve-levity-ly0bt030>

## One Box Universal Concealed Part ONE BOX\_ZB00B031



MODEL **ZB00B031**

One Box Universal Concealed Part, for 1 or 2 or 3 outlet thermostatic or single lever, without trim kit, with noise reducers, with sealing gasket

### AVAILABLE FINISHINGS



### CHARACTERISTICS

Concealed **1**  
Installation **Concealed**



### Thermostatic

The Huber thermostatic is your personal water manager, helping you to handle, control and save water and energy.



## One Box Universal Concealed Part ONE BOX\_ZB00B030



MODEL **ZB00B030**

One Box Universal Concealed Part, for 1 or 2 or 3 outlet thermostatic or single lever, without trim kit, without noise reducers, with sealing gasket

### AVAILABLE FINISHINGS

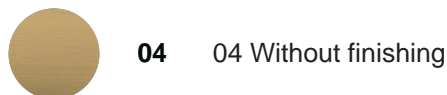

### CHARACTERISTICS

|              |                  |
|--------------|------------------|
| Concealed    | <b>1</b>         |
| Installation | <b>Concealed</b> |



### Thermostatic

The Huber thermostatic is your personal water manager, helping you to handle, control and save water and energy.



2026-06-06