

Exposed part for concealed washbasin mixer LEVITY_LY013510

MODEL **LY013510**

Exposed part for concealed washbasin mixer, without concealed part, for item ZB033511

AVAILABLE FINISHINGS

-  **21** 21 Chrome
-  **2B** 2B Polished Nickel
-  **2F** 2F Brushed Nickel
-  **40** 40 Matt Black
-  **4Q** 4Q Matt White

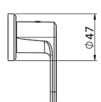
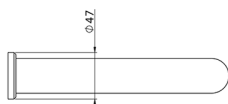
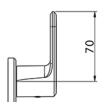
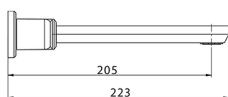
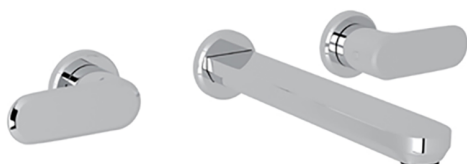

CHARACTERISTICS

Installation **Concealed**

Required concealed parts **ZB033511**



Concealed washbasin mixer CONCEALED_ZB033511

MODEL **ZB033511**

Concealed washbasin mixer, right headvalve - left headvalve

AVAILABLE FINISHINGS



04 04 Without finishing

CHARACTERISTICS

Installation **Concealed**

Concealed **1**

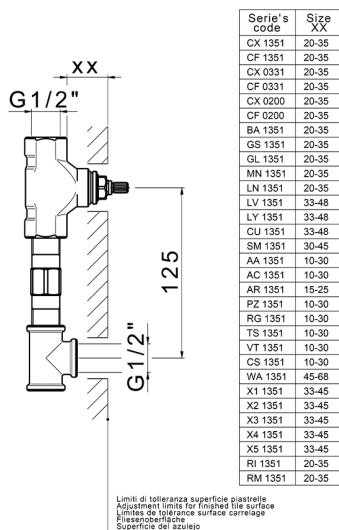

2026-05-15