

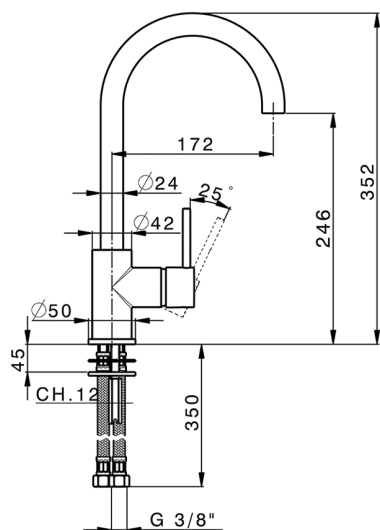





## Single lever sink mixer Energysave NUOVA KIRUNA\_K2000535



MODEL **K2000535**

Single lever mixer Energysave, swivel spout, G.3/8" stainless steel flexible hoses

### AVAILABLE FINISHINGS

-  **21** 21 Chrome
-  **26** 26 Old Copper
-  **2F** 2F Brushed Nickel
-  **2W** 2W Brushed Gold
-  **40** 40 Matt Black
-  **4Q** 4Q Matt White

### CHARACTERISTICS

Cartridge Spare Parts **ZZ95409000**

**35 mm Cartridge**



#### EcoStop

EcoStop feature limits water flow to approximately 50% of maximum output with one point of resistance on setting. Push slightly past the middle stop only when full water output is required. This will save water up to 50%.



#### EnergySave

Thanks to the EnergySave device, only cold water will be drawn if the lever is operated in the central position, so that the water heater will not be engaged and no hot water wasted, leading to considerable savings in energy and costs. The temperature can be adjusted by rotating the lever to the left, until the desired temperature is reached.



2024-09-19