

Exposed part for concealed S.L. shower valve DADO_DD003000

MODEL **DD003000**

Exposed part for concealed S.L. shower valve, without concealed part, for article ZB005300-ZB005301

AVAILABLE FINISHINGS

-  **21** 21 Chrome
-  **2B** 2B Polished Nickel
-  **2F** 2F Brushed Nickel
-  **40** 40 Matt Black
-  **4Q** 4Q Matt White

CHARACTERISTICS

Installation **Concealed**
 Required concealed parts **ZB005301**
ZB005300

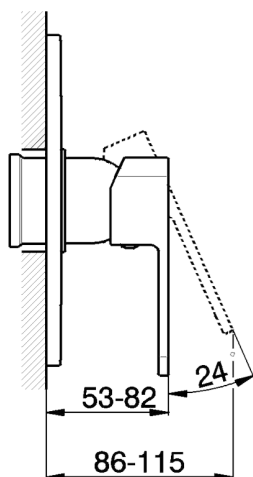

Exposed part for concealed S.L. shower valve DADO_DD003000

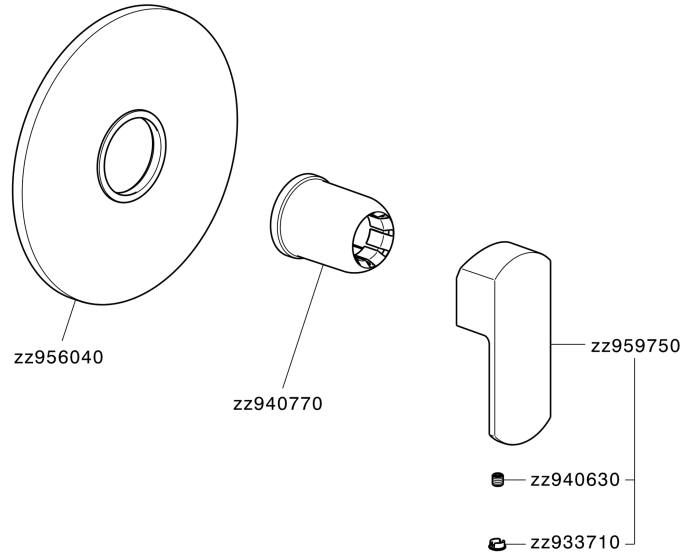

DD003000

<https://en.huberitalia.com/exposed-part-for-concealed-s-l-shower-valve-dado-dd003000>

Concealed single lever shower mixer CONCEALED_ZB005301



MODEL **ZB005301**

Concealed single lever shower mixer, 1/2" concealed shower, without trim kit, with noise reducers

AVAILABLE FINISHINGS



04 04 Without finishing

CHARACTERISTICS

Installation	Concealed
Cartridge Spare Parts	ZZ94035000
35 mm Cartridge	
Concealed	1



Piastra/Plate/Plaque/Platte/Placa
 2-3mm: XX 27-47 YY 54-74
 10mm: XX 16-40 YY 43-68



Concealed single lever shower valve CONCEALED_ZB005300

MODEL **ZB005300**

Concealed single lever shower valve, 1/2" Concealed shower mixer, without trim kit



AVAILABLE FINISHINGS



04 04 Without finishing

CHARACTERISTICS

Installation	Concealed
Cartridge Spare Parts	ZZ94035000
35 mm Cartridge	
Concealed	1



Piastra/Plate/Plaque/Platte/Placa
 2-3mm: XX 27-47 YY 54-74
 10mm: XX 16-40 YY 43-68



2026-06-26