

## Exposed part for concealed S.L. shower valve DADO\_DD003000

MODEL **DD003000**

Exposed part for concealed S.L. shower valve, without concealed part, for article ZB005300-ZB005301

### AVAILABLE FINISHINGS

-  **21** 21 Chrome
-  **2B** 2B Polished Nickel
-  **2F** 2F Brushed Nickel
-  **40** 40 Matt Black
-  **4Q** 4Q Matt White

### CHARACTERISTICS

Installation **Concealed**  
 Required concealed parts **ZB005301**  
**ZB005300**

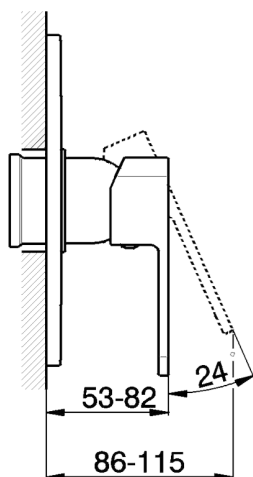

## Exposed part for concealed S.L. shower valve DADO\_DD003000

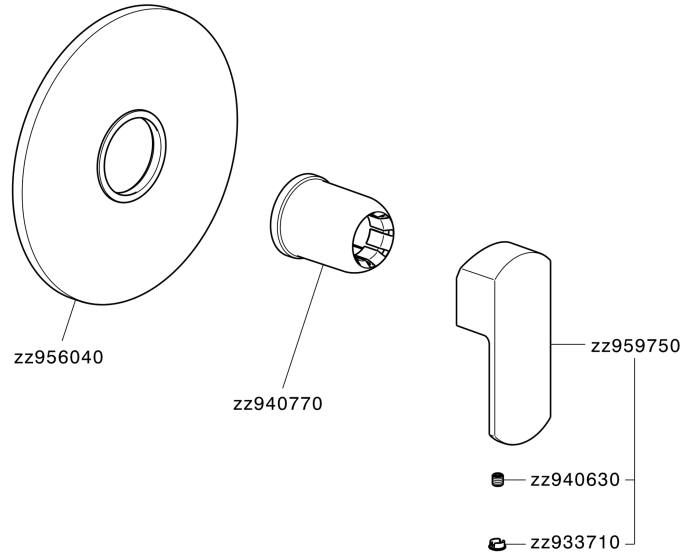

DD003000

<https://en.huberitalia.com/exposed-part-for-concealed-s-l-shower-valve-dado-dd003000>

**Concealed single lever shower mixer CONCEALED\_ZB005301**

MODEL **ZB005301**

Concealed single lever shower mixer, 1/2" concealed shower, without trim kit, with noise reducers



AVAILABLE FINISHINGS

 **04** 04 Without finishing

CHARACTERISTICS

Installation	<b>Concealed</b>
Cartridge Spare Parts	<b>ZZ94035000</b>
<b>35 mm Cartridge</b>	
Concealed	<b>1</b>

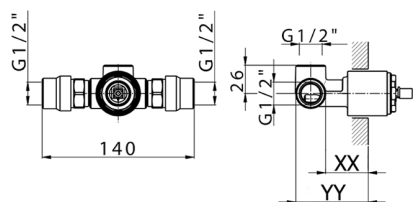

Piastra/Plate/Plaque/Platte/Placa  
 2-3mm: XX 27-47 YY 54-74  
 10mm: XX 16-40 YY 43-68



**Concealed single lever shower valve CONCEALED\_ZB005300**

MODEL **ZB005300**

Concealed single lever shower valve, 1/2" Concealed shower mixer, without trim kit



AVAILABLE FINISHINGS

 **04** 04 Without finishing

CHARACTERISTICS

Installation	<b>Concealed</b>
Cartridge Spare Parts	<b>ZZ94035000</b>
<b>35 mm Cartridge</b>	
Concealed	<b>1</b>

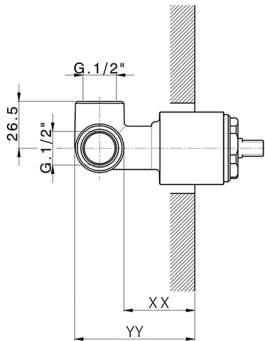

Piastra/Plate/Plaque/Platte/Placa  
 2-3mm: XX 27-47 YY 54-74  
 10mm: XX 16-40 YY 43-68



2026-04-05