

Exposed part for thermostatic concealed valve PUSH&SHOWER_PS0G1020

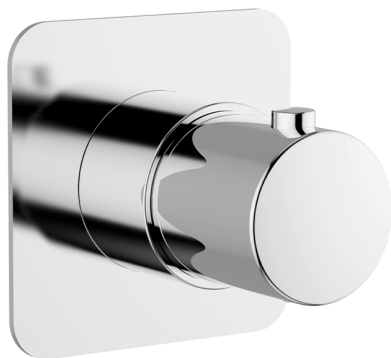

MODEL **PS0G1020**

Exposed part for thermostatic concealed valve, without concealed valve, 80x80mm rounded plate, for Th. concealed valve with protection guard box

AVAILABLE FINISHINGS

-  **21** 21 Chrome
-  **24** 24 Gold
-  **26** 26 Old Copper
-  **2B** 2B Polished Nickel
-  **2F** 2F Brushed Nickel
-  **2W** 2W Brushed Gold
-  **3W** 3W Brushed Black Titanium
-  **5G** 5G Rose Gold
-  **40** 40 Matt Black

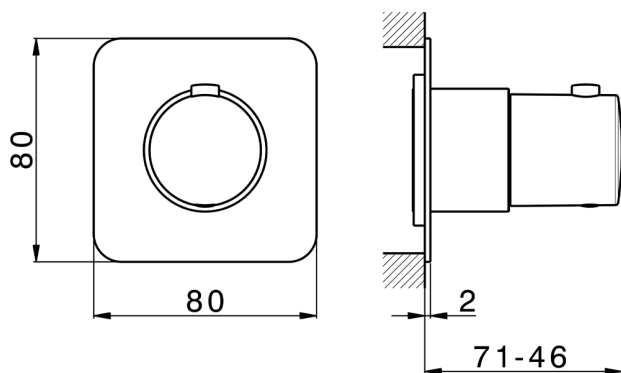

Thermostatic

The Huber thermostatic is your personal water manager, helping you to handle, control and save water and energy.

CHARACTERISTICS

Installation **Concealed**
 Required concealed parts **ZB0G1000**



Thermostatic Concealed part CONCEALED_ZB0G1000

MODEL **ZB0G1000**

Thermostatic Concealed part, without stop valve, with protection guard box, to match with Thermostatic exposed part, without exposed part



AVAILABLE FINISHINGS

 **04** 04 Without finishing

CHARACTERISTICS

Cartridge Spare Parts **22.04A.AR - ZZ97279004**

Argo 2 (long filter) Thermostatic Valve

Concealed **1**

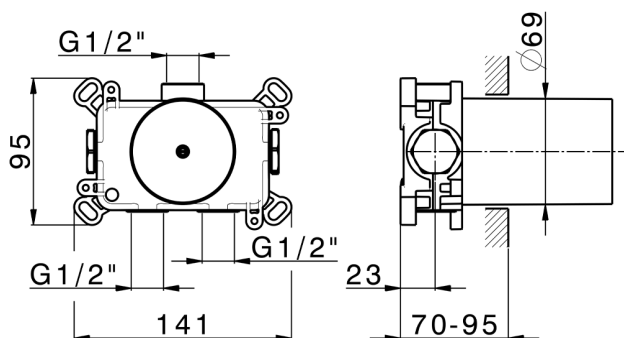

Thermostatic

The Huber thermostatic is your personal water manager, helping you to handle, control and save water and energy.



2024-11-12