







Cover Part for 2 Function Concealed Thermo Valve NUOVA KIRUNA_K201V200

MODEL **K201V200**

Cover Part for 2 Function Concealed Thermo Valve, for item ZB01V200

AVAILABLE FINISHINGS

-  **21** 21 Chrome
-  **26** 26 Old Copper
-  **2F** 2F Brushed Nickel
-  **2W** 2W Brushed Gold
-  **40** 40 Matt Black
-  **4Q** 4Q Matt White

CHARACTERISTICS

Installation **Concealed**
 Required concealed parts **ZB01V200**

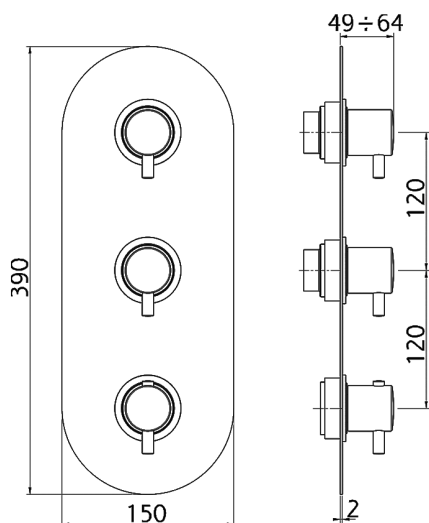

Thermostatic

The Huber thermostatic is your personal water manager, helping you to handle, control and save water and energy.



2 Function Concealed Thermostatic Valve CONCEALED_ZB01V200



MODEL **ZB01V200**

2 Function Concealed Thermostatic Valve

AVAILABLE FINISHINGS



04 04 Without finishing

CHARACTERISTICS

Installation **Concealed**

Cartridge Spare Parts **23.51A.HF**

HF Thermostatic Valve

Concealed **1**

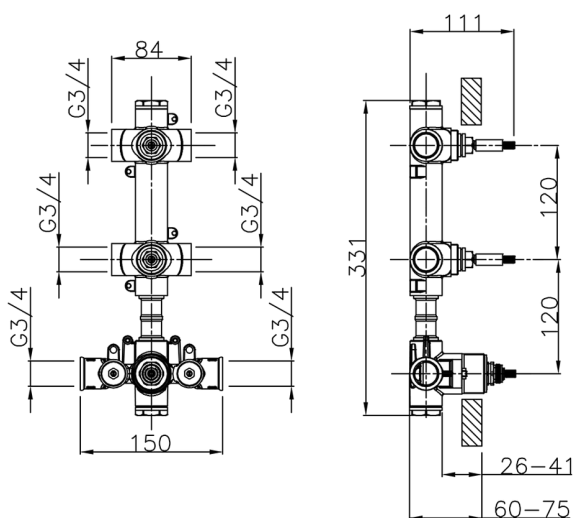

Thermostatic

The Huber thermostatic is your personal water manager, helping you to handle, control and save water and energy.



2026-05-25