

Exposed part for thermostatic concealed valve PUSH&SHOWER_PS0G1020

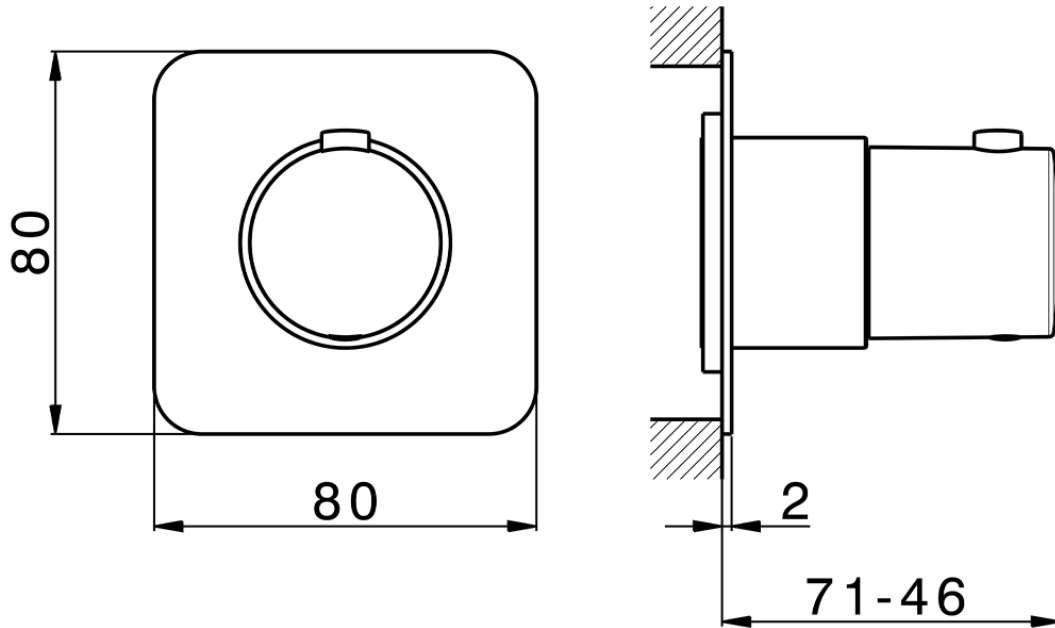

PS0G1020

<https://en.huberitalia.com/exposed-part-for-thermostatic-concealed-valve-pushshower-ps0g1020>

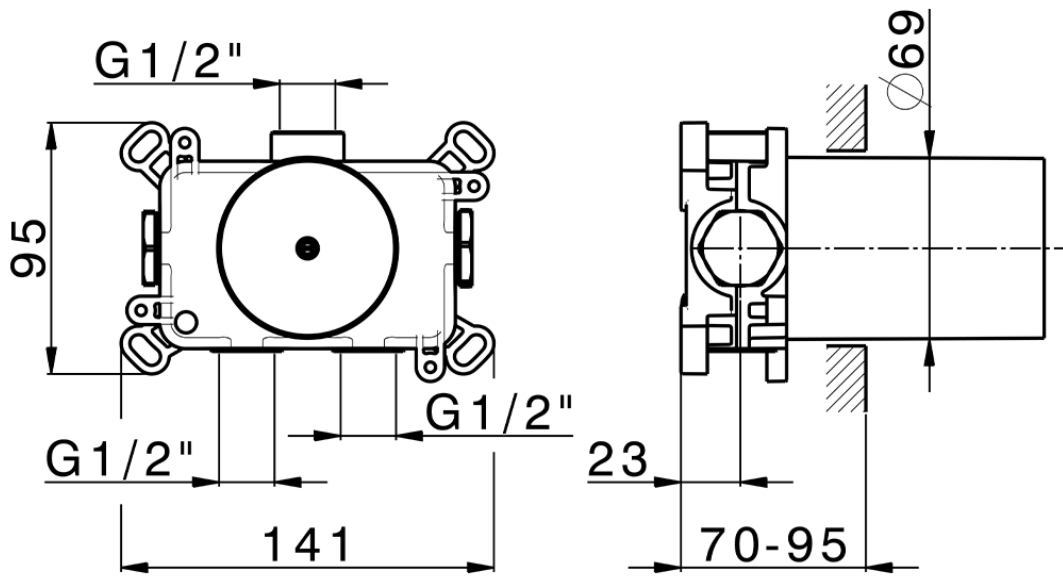

ZB0G1000

<https://en.huberitalia.com/thermostatic-concealed-part-concealed-zb0g1000>

2024-12-18