

## G.1" Concealed rapid flow valve COMPONENTS\_ZB002711

MODEL **ZB002711**

G.1" Concealed rapid flow valve

AVAILABLE FINISHINGS



CHARACTERISTICS

Installation **Concealed**

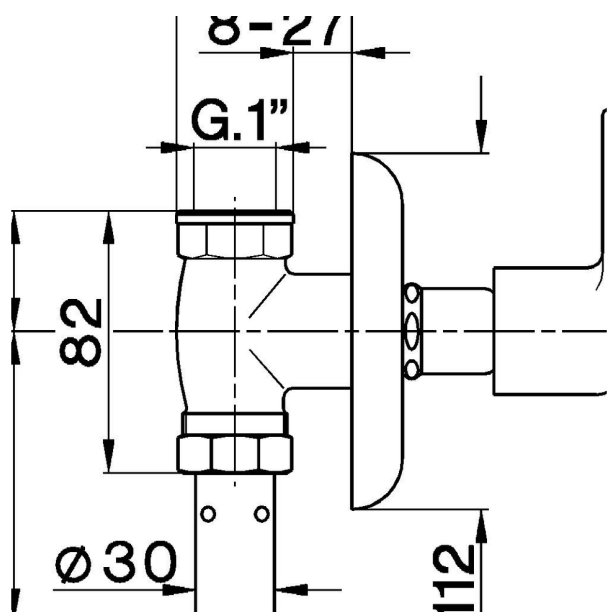

2024-12-18