





## Exposed part for concealed 2-outlet mixer NUOVA EGO\_NE002300

MODEL **NE002300**

Exposed part for concealed 2-outlet mixer, 2-Way rotating diverter, without concealed part, for item Easy-Box ZB000230

### AVAILABLE FINISHINGS

-  **21** 21 Chrome
-  **2F** 2F Brushed Nickel
-  **40** 40 Matt Black
-  **4Q** 4Q Matt White

### CHARACTERISTICS

Installation **Concealed**  
 Required concealed parts **ZB000230**

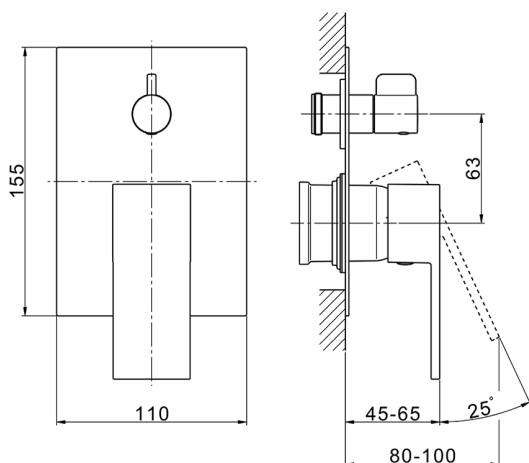

## Concealed single lever bath-shower mixer Easy-Box CONCEALED\_ZB000230

MODEL **ZB000230**

Concealed single lever bath-shower mixer Easy-Box, 2-Way rotating diverter, without trim kit, with protection guard box

AVAILABLE FINISHINGS



**04** 04 Without finishing

CHARACTERISTICS

Installation	<b>Concealed</b>
Cartridge Spare Parts	<b>ZZ92909000</b>
<b>35 mm Cartridge</b>	
Concealed	<b>1</b>



Piastra/Plate/Plaque/Platte/Placa

2-3mm: XX 65-85

10mm: XX 60-80



2026-04-12