

## Exposed part for single lever washbasin valve H2\_H2005511

MODEL **H2005511**

Exposed part for single lever washbasin valve, without concealed part, spout L.200 mm, for item Easy-Box ZB002450 and art. ZB025510



AVAILABLE FINISHINGS



CHARACTERISTICS

Installation **Concealed**

Required concealed parts **ZB002450**

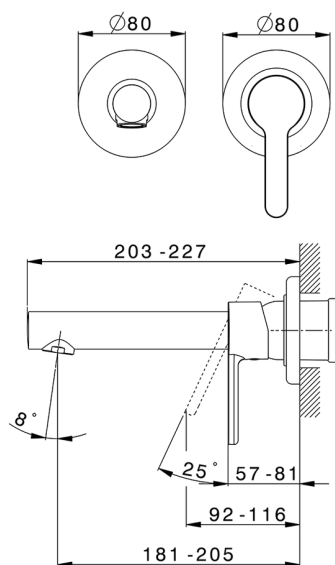

## Exposed part for single lever washbasin valve H2\_H2005511

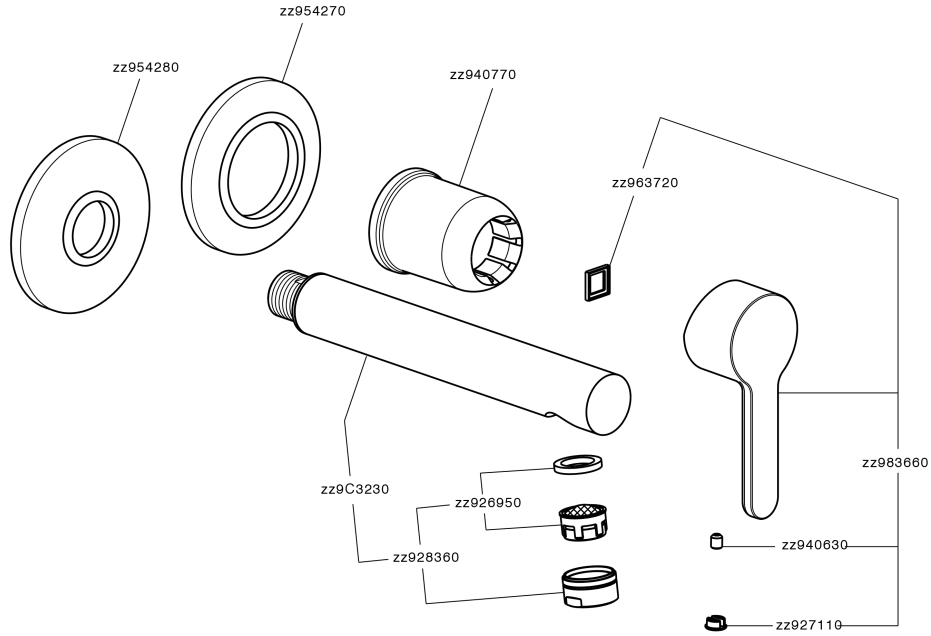

H2005511

<https://en.huberitalia.com/exposed-part-for-single-lever-washbasin-valve-h2-h2005511>

## Concealed single lever washbasin mixer Easy-Box CONCEALED\_ZB002450

MODEL **ZB002450**

Concealed single lever washbasin mixer  
Easy-Box, with protection guard box, without trim kit

AVAILABLE FINISHINGS



CHARACTERISTICS

Installation	<b>Concealed</b>
Cartridge Spare Parts	<b>ZZ95409000</b>
<b>35 mm Cartridge</b>	
Concealed	<b>1</b>



Piastra/Plate/Plaque/Platte/Placa

2-3mm: XX 56-76

10mm: XX 48-68



### DeviaStop

The Huber Devia Stop technology allows to adjust the water flow and to direct it to the selected output point (overhead soaker, hand shower, etc).



2026-04-28