

Exposed simple tap EVA_EV001520

MODEL **EV001520**

Exposed simple tap, without handle

AVAILABLE FINISHINGS



CHARACTERISTICS

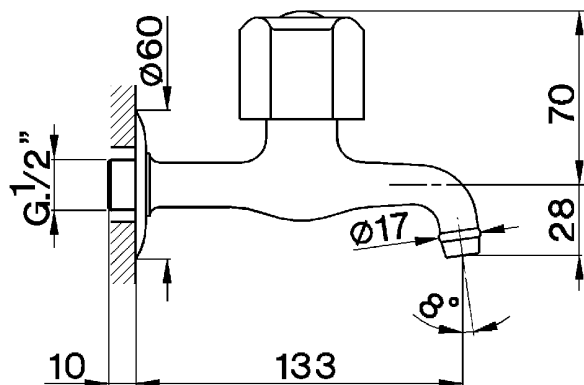

2025-01-05