

Double towel holder BATHROOM ACCESSORIES_SQ090210

MODEL **SQ090210**

Double towel holder,swivel

AVAILABLE FINISHINGS

-  **21** 21 Chrome
-  **2B** 2B Polished Nickel
-  **2F** 2F Brushed Nickel
-  **2Q** 2Q Black Titanium
-  **40** 40 Matt Black
-  **4Q** 4Q Matt White

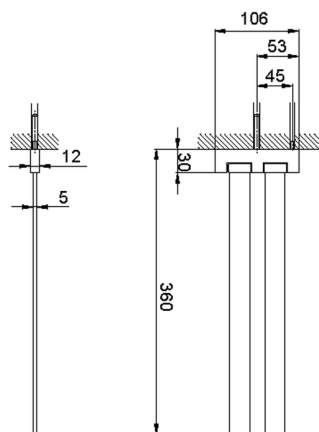
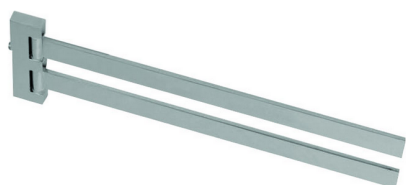

CHARACTERISTICS



Double towel holder BATHROOM ACCESSORIES_SQ090210

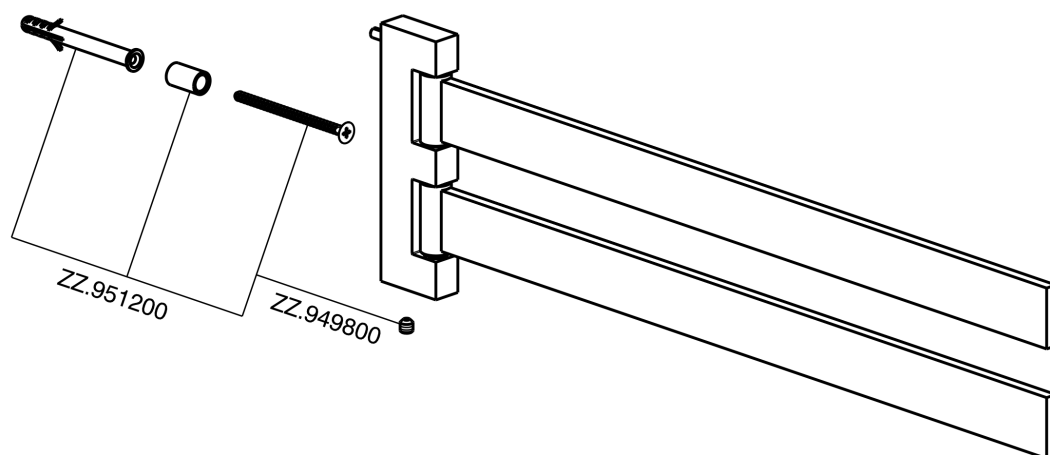

SQ090210

<https://en.huberitalia.com/double-towel-holder-bathroom-accessories-sq090210>

2026-04-08