

Concealed stop valve COMPONENTS_ZB000310

MODEL **ZB000310**

Concealed stop valve, 1/2" F outlet

AVAILABLE FINISHINGS



CHARACTERISTICS

Installation **Concealed**

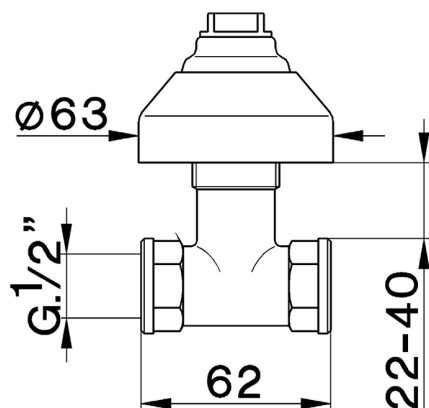

2026-04-06