

## Single lever washbasin mixer H2\_H2000510



MODEL **H2000510**

Single lever washbasin mixer, with 1"1/4 automatic pop-up waste, G.3/8" stainless steel flexible hoses

AVAILABLE FINISHINGS



CHARACTERISTICS

Cartridge Spare Parts **ZZ95435000**

**35 mm Cartridge**

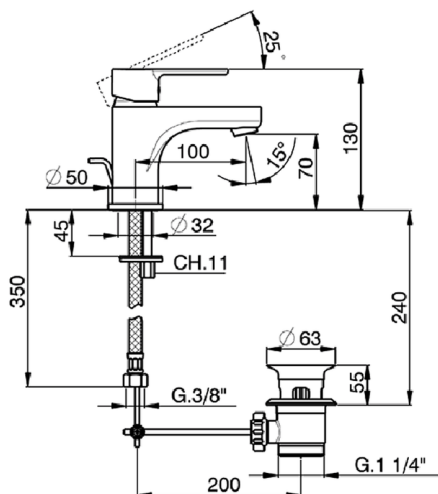

### EcoStop

EcoStop feature limits water flow to approximately 50% of maximum output with one point of resistance on setting. Push slightly past the middle stop only when full water output is required. This will save water up to 50%.



2026-06-13