

1"1/4 click clack drain for basin mixer COMPONENTS_ZB001790

MODEL **ZB001790**

1"1/4 click clack drain for basin mixer, for overflow bath drain system, for bath drain system without overflow, for thickness Max from 0-100 mm, waste body made of plastic material



AVAILABLE FINISHINGS

-  **D1** D1 Brushed Inox
-  **26** 26 Old Copper
-  **2W** 2W Brushed Gold
-  **40** 40 Matt Black
-  **4Q** 4Q Matt White
-  **D2** D2 Polished Inox

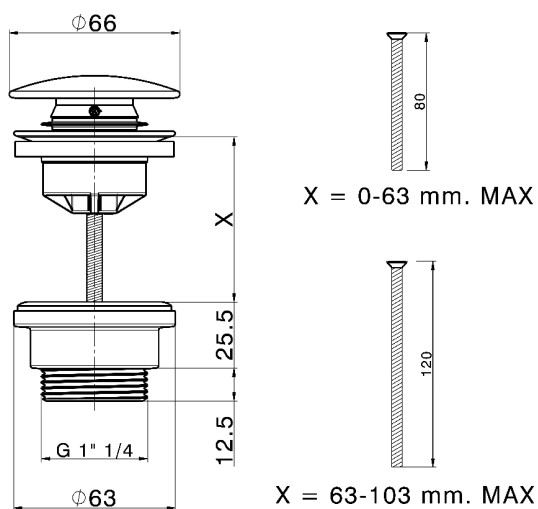

CHARACTERISTICS



1"1/4 click clack drain for basin mixer COMPONENTS_ZB001790

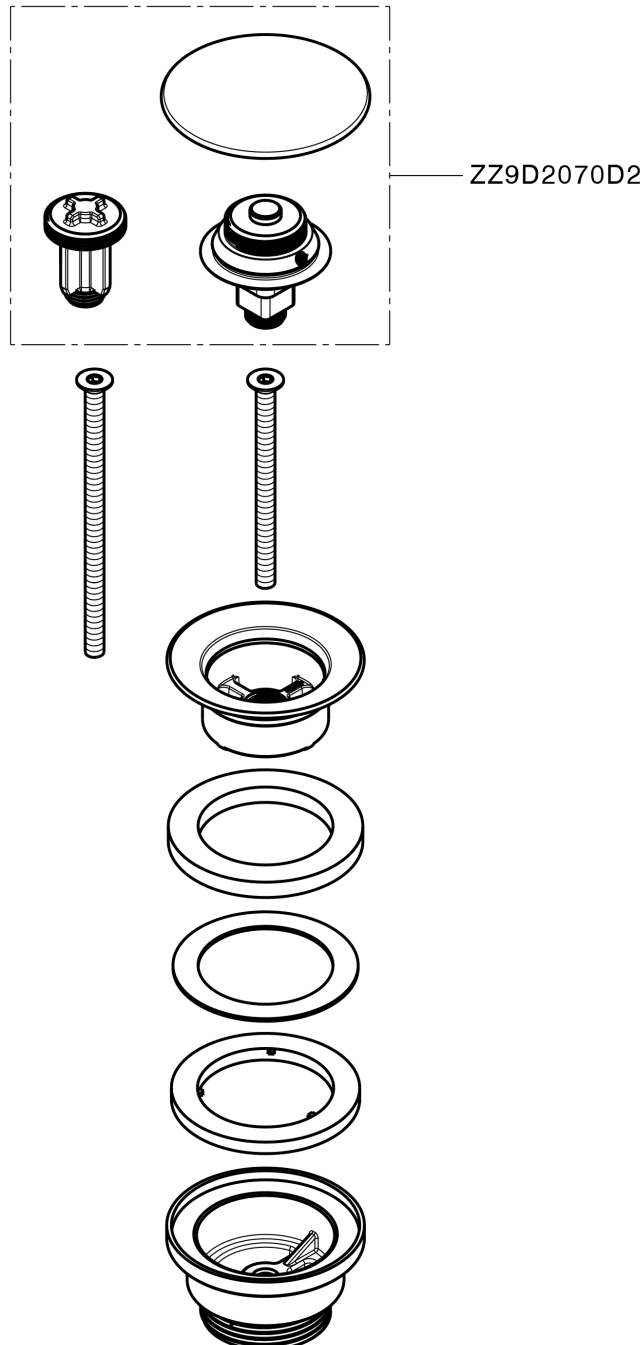

ZB001790

<https://en.huberitalia.com/11-4-click-clack-drain-for-basin-mixer-components-zb001790>

2026-04-09