

Cover Part for 3 Function Concealed Thermo. Valve NUOVA KIRUNA_K201R300

MODEL **K201R300**

Cover Part for 3 Function Concealed Thermo.Valve,for item ZB01R300

AVAILABLE FINISHINGS

-  **21** 21 Chrome
-  **26** 26 Old Copper
-  **2F** 2F Brushed Nickel
-  **2W** 2W Brushed Gold
-  **40** 40 Matt Black
-  **4Q** 4Q Matt White

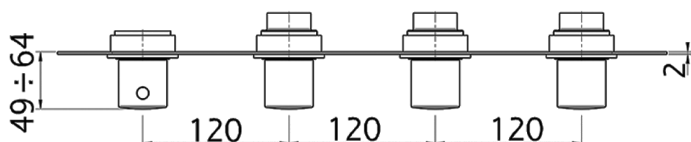
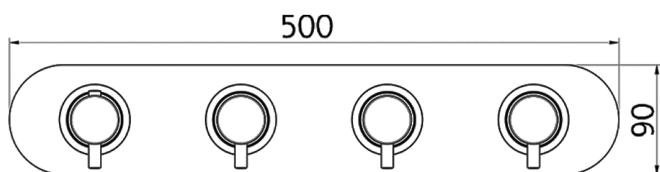
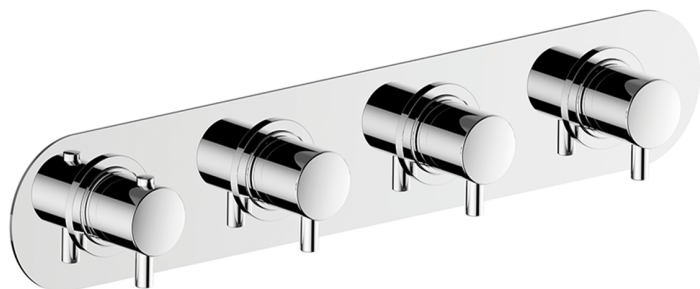

CHARACTERISTICS

Installation **Concealed**
 Required concealed parts **ZB01R300**



Thermostatic

The Huber thermostatic is your personal water manager, helping you to handle, control and save water and energy.



3 Function Concealed Thermostatic Built-in Part CONCEALED_ZB01R300

MODEL **ZB01R300**

3 Function Concealed Thermostatic Built-in Part

AVAILABLE FINISHINGS

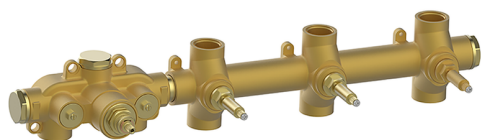

CHARACTERISTICS

Installation	Concealed
Cartridge Spare Parts	23.51A.HF
HF Thermostatic Valve	
Concealed	1

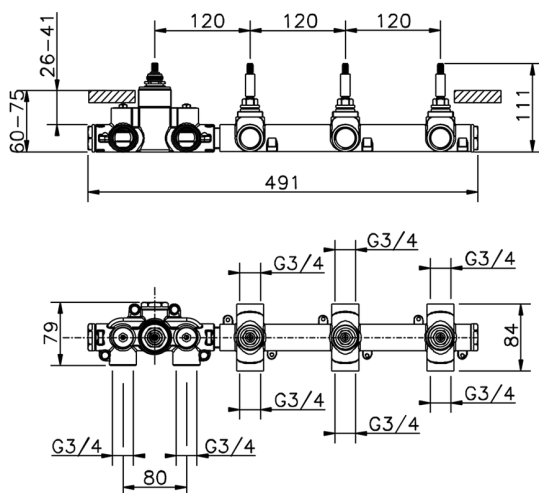

Thermostatic

The Huber thermostatic is your personal water manager, helping you to handle, control and save water and energy.



2026-04-08