







Cover Part for 2 Function Concealed Thermo Valve NUOVA KIRUNA_K201R200

MODEL **K201R200**

Cover Part for 2 Function Concealed Thermo Valve, for item ZB01R200

AVAILABLE FINISHINGS

-  **21** 21 Chrome
-  **26** 26 Old Copper
-  **2F** 2F Brushed Nickel
-  **2W** 2W Brushed Gold
-  **40** 40 Matt Black
-  **4Q** 4Q Matt White

CHARACTERISTICS

Installation **Concealed**
 Required concealed parts **ZB01R200**

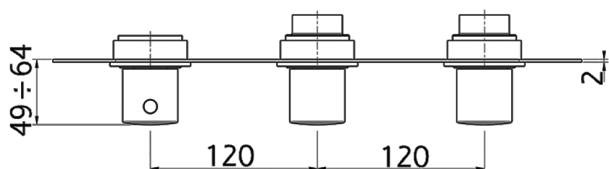
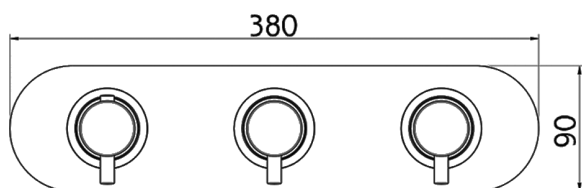
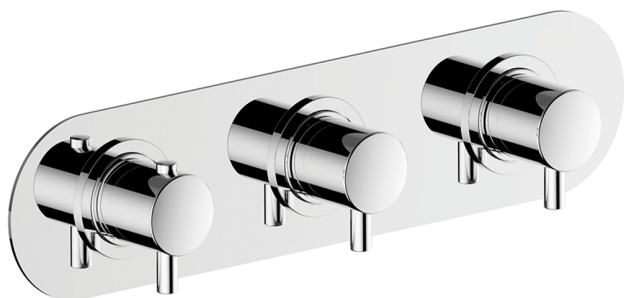

Thermostatic

The Huber thermostatic is your personal water manager, helping you to handle, control and save water and energy.



2 Function Concealed Thermostatic Valve CONCEALED_ZB01R200

MODEL **ZB01R200**

2 Function Concealed Thermostatic Valve

AVAILABLE FINISHINGS

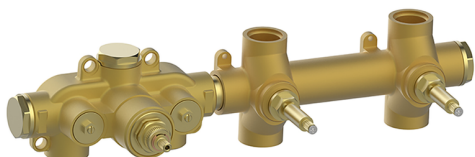
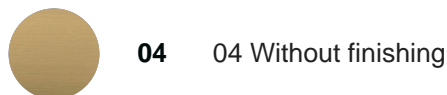

CHARACTERISTICS

Installation	Concealed
Cartridge Spare Parts	23.51A.HF
HF Thermostatic Valve	
Concealed	1

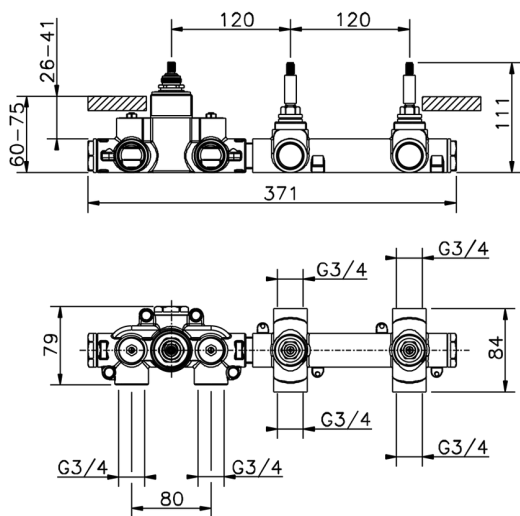

Thermostatic

The Huber thermostatic is your personal water manager, helping you to handle, control and save water and energy.



2024-12-22