

## Exposed part for con.thermo.shower valve, 3-outlet LEVITY\_LY018200

MODEL **LY018200**

Exposed part for 3-outlet thermostatic mixer, with 3 outlet diverter, without concealed part, for item ZB018201

### AVAILABLE FINISHINGS

-  **21** 21 Chrome
-  **2B** 2B Polished Nickel
-  **2F** 2F Brushed Nickel
-  **40** 40 Matt Black
-  **4Q** 4Q Matt White

### CHARACTERISTICS

Installation **Concealed**  
 Required concealed parts **ZB018201**



### Thermostatic

The Huber thermostatic is your personal water manager, helping you to handle, control and save water and energy.



## 3-outlet Concealed thermostatic shower valve CONCEALED\_ZB018201

MODEL **ZB018201**

3-Outlet Concealed thermostatic mixer, with 3-outlet diverter, without trim kit

AVAILABLE FINISHINGS



CHARACTERISTICS

Installation	<b>Concealed</b>
Cartridge Spare Parts	<b>24.04A.PP</b>
<b>8x20 Plus P Thermostatic Valve</b>	
Concealed	<b>1</b>

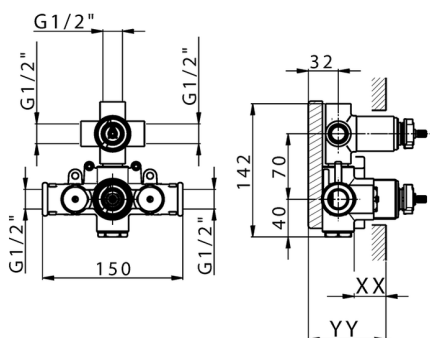

Piastra/Plate/Plaque/Platte/Placa

2-3mm: XX 25-40 YY 76-91

10 mm: XX 16-31 YY 65-80



### DeviaStop

The Huber Devia Stop technology allows to adjust the water flow and to direct it to the selected output point (overhead soaker, hand shower, etc).



### Thermostatic

The Huber thermostatic is your personal water manager, helping you to handle, control and save water and energy.



2026-04-06