







## Towel holder BATHROOM ACCESSORIES\_SQ090105

MODEL **SQ090105**

Towel holder

### AVAILABLE FINISHINGS

- 
**21** 21 Chrome
- 
**2B** 2B Polished Nickel
- 
**2F** 2F Brushed Nickel
- 
**2Q** 2Q Black Titanium
- 
**40** 40 Matt Black
- 
**4Q** 4Q Matt White

### CHARACTERISTICS

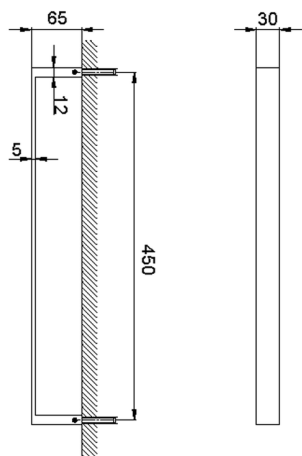
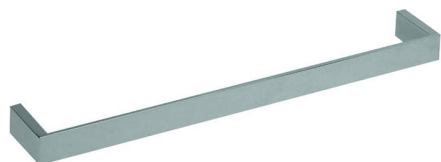

2024-12-22