







## Towel holder BATHROOM ACCESSORIES\_SQ090105

MODEL **SQ090105**

Towel holder

### AVAILABLE FINISHINGS

-  **21** 21 Chrome
-  **2B** 2B Polished Nickel
-  **2F** 2F Brushed Nickel
-  **2Q** 2Q Black Titanium
-  **40** 40 Matt Black
-  **4Q** 4Q Matt White

### CHARACTERISTICS

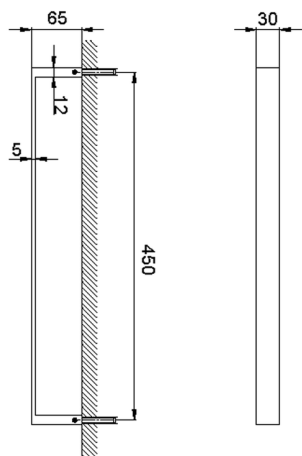
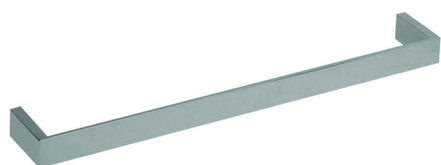

2024-11-23