

Exposed part for individual Push&Shower PUSH&SHOWER_PS0G6110

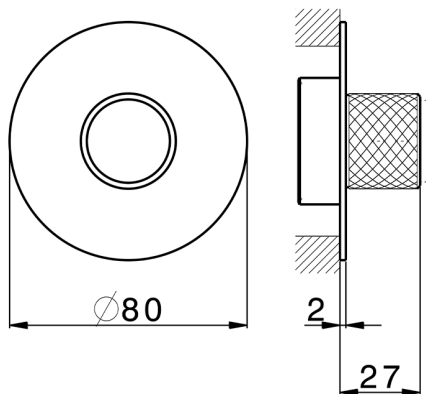

MODEL **PS0G6110**

Exposed part for individual Push&Shower, with knurled button, Ø80mm round plate, for concealed Push&Shower

AVAILABLE FINISHINGS

-  **21** 21 Chrome
-  **24** 24 Gold
-  **26** 26 Old Copper
-  **2B** 2B Polished Nickel
-  **2F** 2F Brushed Nickel
-  **2W** 2W Brushed Gold
-  **3W** 3W Brushed Black Titanium
-  **5G** 5G Rose Gold
-  **40** 40 Matt Black



Thermostatic

The Huber thermostatic is your personal water manager, helping you to handle, control and save water and energy.

CHARACTERISTICS

Installation **Concealed**
 Required concealed parts **ZB0G6000**



Parte empotrada Push&Shower PUSH&SHOWER_ZB0G6000

MODEL **ZB0G6000**

Push&Shower concealed valve, ON/OFF button with flow rate regulation, with protection guard box, to match with Push&Shower exposed part, without exposed part



AVAILABLE FINISHINGS



CHARACTERISTICS

Argo 2 (long filter) Thermostatic Valve

Concealed **1**



2024-09-19