

Multi-point thermostatic valve COMMUNITY_445.PR01H.

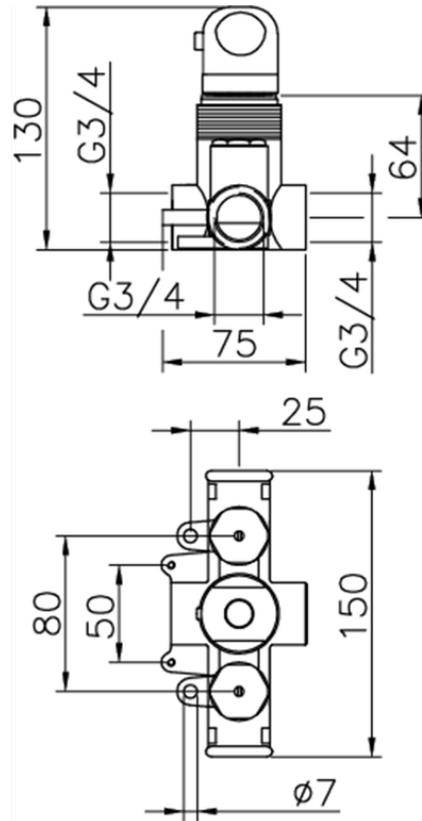

445.PR01H.

<https://en.huberitalia.com/multi-point-thermostatic-valve-community-445-pr01h>

2026-04-05