

Single lever tall washbasin mixer DADO_DD003540

DD 00354 0

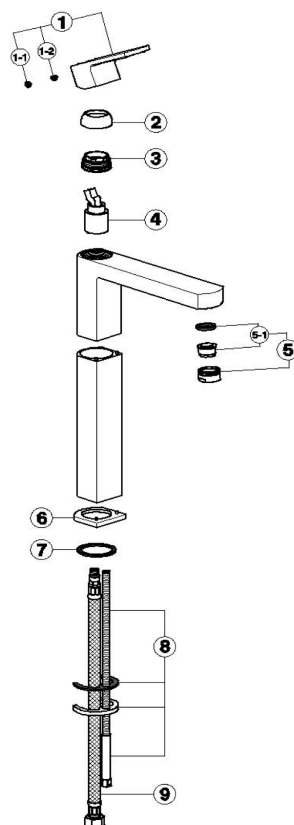
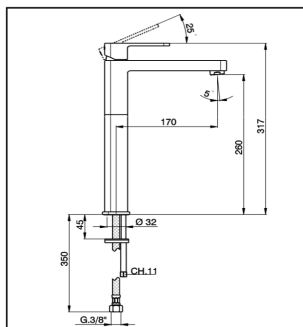

NR	DESCRIZIONE DESCRIPTION DESCRIPCION	N.CODICE NR.CODE CODE NO. WERSKNR. N.CÓDIGO	NR	DESCRIZIONE DESCRIPTION DESCRIPCION	N.CODICE NR.CODE CODE NO. WERSKNR. N.CÓDIGO	NR	DESCRIZIONE DESCRIPTION DESCRIPCION	N.CODICE NR.CODE CODE NO. WERSKNR. N.CÓDIGO
1	Leva monocomando "DD" Lever "DD" Hebel "DD" Palanca monomando "DD"	ZZ955930	5	Aeratore M24x1 IA Cascade Mousseur M24x1 IA Cascade Mousseur M24x1 IA Cascade Perlator M24x1 IA Cascade Aireador M24x1 IA Cascade	ZZ944150			
1-1	Placchetta maniglia LS Plaque cache - vis crois LS Cap for handle LS Abdeckkappe LS Griff Plaquita maneta LS	ZZ933710	5-1	Cartuccia per aeratore M.24x1 Cascade Cartouche pour mousseur M.24x1 Cascade Mousseur cartridge M.24x1 Cascade Kartusche fuer Perlator M.24x1 Cascade Cartucho para aireador M.24x1 Cascade	ZZ933990			
1-2	Grano punta coppa inox M.5x6 Vis speciale inox M.5x6 Screw-stainless steel M.5x6 Madenschraube M.5x6 Clavija con punta copa acero inox M.5x6	ZZ940630	6	Basetta monocomando "DD" Bague "DD" Assembling ring "DD" Basis "DD" Base monomando lavabo "DD"	ZZ955230			
2	Copricartuccia monocomando Couvre-cartouche Escutcheon cartridge Abdeckkappe Cubre-cartucho monomando Calotta bloccaggio cartuccia Ecrou pour cartouche	ZZ955210	7	Guarnizione 42x35x2 Joint 42x35x2 Gasket 42x35x2 Dichtung 42x35x2 Junta 42x35x2	ZZ955240			
3	Nut for mixing valve Mutter fuer Kartusche Casquete de fijación cartucho	ZZ955220	8	Set installazione Set installation Installation set single lever Befestigungsset Juego de instalación monomando	ZZ954250			
4	Cartuccia monocomando Cartouche mitigeurs Mixing valve Kartusche Cartucho monomando	ZZ942400	9	Flex M. 10x1 3/8" F L.610 Flex M. 10x1 3/8" F L.610 Flex M. 10x1 3/8" F L.610 Anschlusschlauch M.10x1 3/8" F L.610 Flexo M. 10x1 3/8" H L.610	ZZ955250			

DD003540

<https://en.huberitalia.com/single-lever-tall-washbasin-mixer-dado-dd003540>

2026-06-28